

Chanarambie Substation Expansion Project

Storm Water Pollution Prevention Plan for Construction Activities

**Prepared for
Xcel Energy**

Prepared by

**HDR Engineering, Inc.
701 Xenia Avenue South, Suite 600
Minneapolis, MN 55416**

October 2007

Table of Contents

NPDES REQUIREMENTS.....	3
PROJECT DESCRIPTION	3
POTENTIAL FOR STORMWATER POLLUTION.....	5
Land Use	5
Soils.....	5
Natural Features and Overland Slope	5
Precipitation	5
CONSTRUCTION ACTIVITIES	5
Expanding the Substation Facility	5
TEMPORARY EROSION AND SEDIMENT CONTROL BMPS.....	6
Temporary Construction Entrances/Exits	6
Silt Fence.....	7
Rock Checks	7
Protecting Soil Stockpiles.....	7
Control of Surface Water.....	7
Sediment Traps	7
Temporary Seeding.....	7
Seed Mixture	8
Seed Bed Preparation.....	8
Mulch	8
Rapid Stabilization.....	8
PERMANENT EROSION AND SEDIMENT CONTROL BMPS	11
Turf Establishment	11
Seed Bed Preparation.....	11
Mulch and Blanket.....	11
INSPECTIONS AND MAINTENANCE	12
Inspections	12
Maintenance	12
POLLUTION PREVENTION MANAGEMENT MEASURES	13
Spills Clean	13
Trash and Debris	13
Hazardous Materials	13
Truck Washing.....	13
Dust Control	13
PERMANENT STORMWATER MANAGEMENT MEASURE.....	13
PLAN MODIFICATIONS	13
NOTICE OF TERMINATION.....	14

List of Figures

Figure 1 Project Location Map	2
Figure 2 Grading/Erosion Control Plan	10

List of Appendices

Appendix A	MPCA General Construction Permit – MN R10001
Appendix B	Erosion Control Details
Appendix C	Seed Mixture Composition
Appendix D	Inspection Log
Appendix E	Revision Documentation
Appendix F	Notice of Termination

NPDES REQUIREMENTS

Construction activities resulting in disturbance of one acre or more of land must be covered under the National Pollutant Discharge Elimination System (NPDES) General Permit for Construction Activities. In addition, sites disturbing less than one acre within in a larger common plan of development or sale that is more than one acre, also need NPDES Permit coverage. A Storm Water Pollution Prevention Plan (SWPPP) must be crafted to meet the site-specific requirements of each project. The Owner must submit to the Minnesota Pollution Control Agency (MPCA) a Notice of Intent (NOI) at least seven (7) calendar days prior to the commencement of construction activities.

A typical SWPPP covers five items:

1. Temporary erosion and sediment control best management practice (BMPs)
2. Permanent erosion and sediment control BMPs
3. Permanent stormwater management
4. Pollution prevention management measures
5. Inspection and maintenance

A copy of the MPCA General Construction Permit (MN R100001) and the project NOI are included in Appendix A.

PROJECT DESCRIPTION

The Chanarambie Substation Project consists of the expansion of a substation located in Township 106 north, Range 43 west, Section 6 in Murray County, Minnesota (Figure 2). The existing substation covers 3.75 acres; the planned expansion will disturb approximately 1.07 acres immediately to the southeast of the existing substation. The receiving waterway is an unnamed tributary of the East Branch Rock River. Construction slated for this site involves activities that shall expose soil to erosion. The activities covered in the SWPPP include the following:

- Clearing and grading
- Construction associated with the expansion of the existing Chanarambie Substation

The conditions used to select erosion and sediment control BMPs include the following:

- Land use
- Soil type
- Natural features and overland slope
- Precipitation

Figure 1. CHANARAMBIE SUBSTATION LOCATION

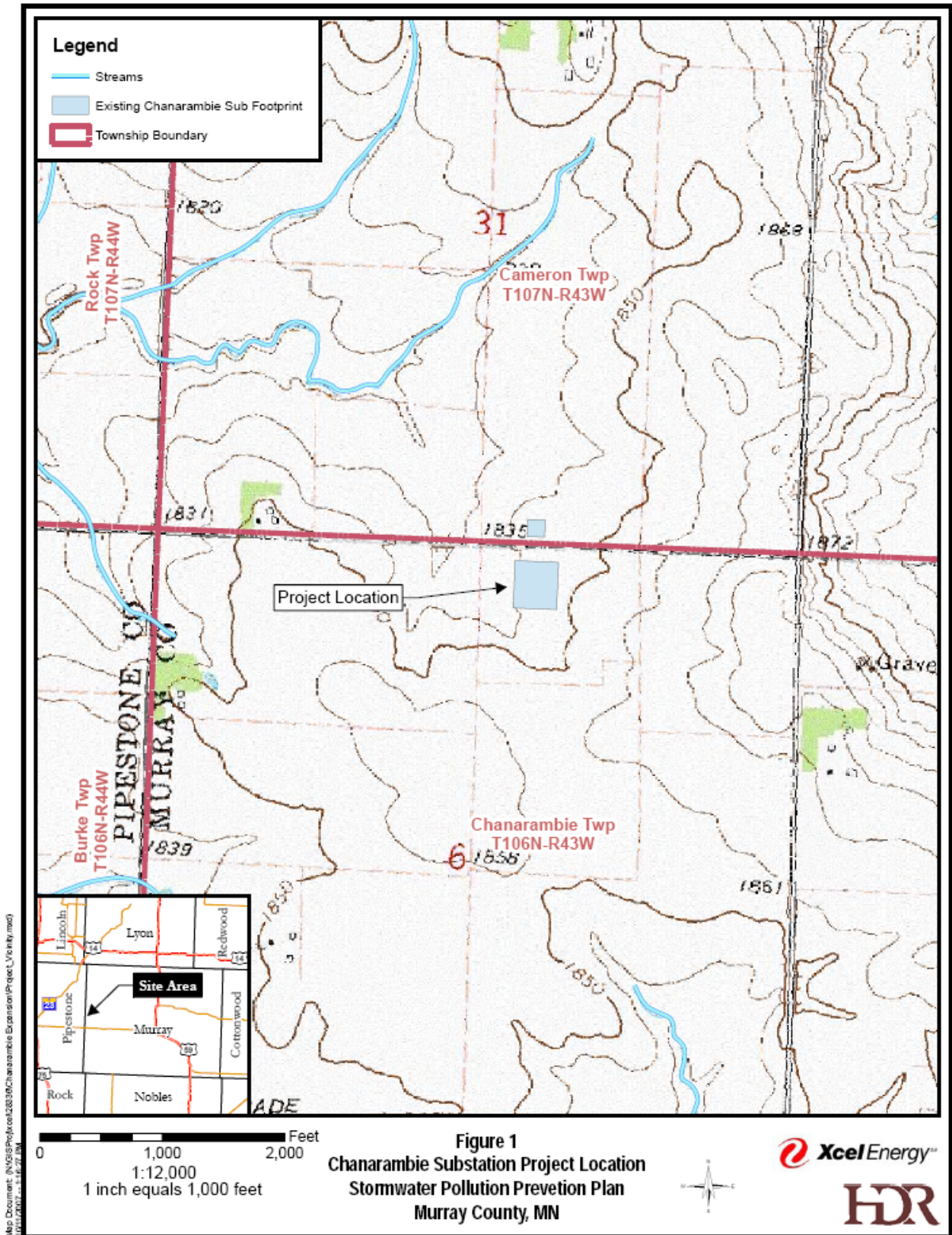

POTENTIAL FOR STORMWATER POLLUTION

LAND USE

Existing land use in this area is transitional agricultural land with rural development.

SOILS

The main soil association within the project area is Lamoure and with a small area of Lismore soils within the eastern project area as recorded on the Murray County GIS-based soil survey. The Lamoure soil series is occasionally flooded silty clay loam considered non-highly erodible land. This is a hydric soils series. The Lismore soil series is silty clay loam and is non-highly erodible. Both are soil classifications are prime farmland soils if properly drainage in the case of the Lamoure soil series.

NATURAL FEATURES AND OVERLAND SLOPE

The project area represents negligible slope.

PRECIPITATION

Average yearly rainfall for south central Minnesota ranges from 25 to 26 inches. Individual storms during spring and summer can produce significant quantities of rainfall. For instance, a 1-year/ 24-hour or 2-year/24-hour storm can produce approximately 2.3 inches or 2.7 inches of rainfall, respectively. Methods shall be needed to manage runoff during and after construction.

Without erosion and sediment control BMPs, the project could produce sediment. The function of this SWPPP is to outline procedures to minimize erosion and mitigate sediment during construction of the basins.

CONSTRUCTION ACTIVITIES

The Contractor shall schedule and conduct all operations to minimize the exposure of soils to erosion and provide means to trap sediments leaving the site. Installation of temporary control measures that shall contribute to the control of erosion and prevention of sediment leaving the site shall be carried out prior to and concurrently with construction activities.

The SWPPP provides structural and non-structural activity-specific erosion and sediment control BMPs. Erosion and sediment control BMPs selected for each activity are based upon expected construction conditions and methods. The plan can be modified in accordance with actual conditions encountered in the field.

EXPANDING THE SUBSTATION FACILITY

Construction of the substation shall involve the stripping of topsoil and excavation of additional material for the construction of foundations.

TEMPORARY EROSION AND SEDIMENT CONTROL BMPS

A sequence for installation of erosion and sediment control BMPs, stabilization activities, and maintenance shall be prepared by the Contractor and included into the SWPPP. General principles in developing the sequence of activities include, but are not limited to, the following:

- Install downslope and sideslope perimeter controls before the land disturbing activity occurs.
- Do not disturb an area until it is necessary for construction to proceed.
- Cover or stabilize disturbed areas as soon as possible.
- Time construction activities to limit impact from seasonal climate changes or weather events.
- Do not remove temporary perimeter controls until after all upstream areas reach final stabilization.

Temporary controls for construction activities include the following:

- Installing/modifying construction entrances
- Silt fence
- Ditch checks
- Protecting soil stockpiles
- Control of surface water
- Sediment trap
- Temporary seeding
- Mulching
- Rapid stabilization

The structural BMPs shall be installed as shown on Figure 2 and details in Appendix B unless noted below.

TEMPORARY CONSTRUCTION ENTRANCES/EXITS

To prevent sediments from being tracked off site, the existing driveway entrance on the north side of the northeast waste area shall be modified. The existing construction entrances shall be modified by overlaying geotextile fabric with a 6-inch of class V (5). Vegetation and topsoil shall not be removed from the shoulder zones to modify the entrances, but tall vegetation may be mowed. If entrance begins to rut, stabilize by placing a geogrid and additional class V (5) in roadway.

The entrances radius shall be reduced and the area restored to the geometry of a rural county road intersection at the end of the project. Areas outside of the permanent roadway shoulder may require re-grading. Compacted soils shall be loosened by ripping or disking, then re-vegetated and mulched.

SILT FENCE

Silt fence shall be installed around staging areas and stockpiles, as needed (Figure 2). Silt fence shall be either machine sliced into the soil, or installed by hand. Hand installed silt fence shall have the edge buried, as shown on the detail sheets, or weighted by sand bags.

In the areas adjacent to the stockpile/ waste areas, sand bags can be used as a substitute to silt fence.

ROCK CHECKS

Two-foot high rock checks shall be installed in ditches approximately 90 feet apart along the perimeter of the substation pad as shown on Figure 2. Biorolls may be used as a substitute.

PROTECTING SOIL STOCKPILES

It is envisioned that some of the excavated materials shall be suitable for backfill and site restoration. Topsoil and organic soils stripped prior to excavation shall be stockpiled separately from materials suitable for backfill or access road embankment. Unsuitable material shall be promptly removed from the site or stockpiled in excess material waste areas until removal is possible. Silt fence or sand bags shall be installed around the entire perimeter of stockpiles to prevent sediment from leaving the designation location.

CONTROL OF SURFACE WATER

Control of surface water will not be necessary during the project as flow will be restricted onsite.

SEDIMENT TRAPS

Sediment laden discharge from dewatering operations shall be directed to perimeter silt fence. The contractor shall consider the use of additional silt fence or hale bales to trap sediment if the perimeter fence cannot handle the flow. (See Appendix B).

TEMPORARY SEEDING

In pastures and ditch side slopes, when disturbed soils are left exposed or permanent turf establishment is not possible due to seasonal restrictions, then apply the appropriate temporary seed mix for the time of year and apply straw mulch. The Contractor shall apply the following as deemed appropriate for the season and construction activities.

Type of Slope	Exposure Time	Maximum time an area can remain open when the area is not actively being worked.
Steeper than 3:1	7 days	
10:1 to 3:1	14 days	
Flatter than 10:1	21 days	

Seed Mixture

Purpose	Seed Mixture	Application Rate
Fall Cover	100	100 lbs/ac
Spring/Summer Cover	110	100 lbs/ac
1 to 2 years of Cover	150	40 lbs/ac
2 to 5 years of Cover	190	60 lbs/ac

Seed mixture 100 is oats for temporary spring/summer seeding of areas that shall be left undisturbed for 21 to 120 days. Seed mixture 110 is winter wheat for temporary fall seeding of areas that shall not be completed before winter and shall be re-disturbed in the spring. Seed mixtures 150 and 190 are temporary mixes, which provide a quick cover for one to two growing seasons and two to five growing seasoning, respectively (Appendix C).

Seed Bed Preparation

Prepare seedbed to a depth of 3 inches. Slopes steeper than 1:2 shall not require loosening as long as the Contractor stabilizes the slopes as they are opened up or created. Soil tests are recommended to determine the appropriate fertilizer analysis and application rate. If a soils test can not be obtained, apply 200 pounds (lb) of 10-10-20 fertilizer per acre and incorporate it into the seedbed.¹ Roll the area to be seeded with an approved cultipacker.

MULCH

The Contractor shall use Type 1 straw mulch at a rate of 2 tons per acre in conjunction with temporary seed mixture on slopes 1:3 or flatter. The mulch shall be disk-anchored or guar gum tackifier shall be used to anchor the straw mulch. For slopes 1:3 or steeper, Type 4 mulch or Type 6 hydraulic soil stabilizer shall be used.

RAPID STABILIZATION

The normal wetted perimeter of any temporary or permanent drainage ditch that drains water from a construction site, or diverts water around a site, must be stabilized within 200 lineal feet from the property edge, or from the point of discharge to any surface water of the state.

¹ District 7 Turf Establishment Recommendation: MN/DOT Technical Memo dated November 14, 2005.

Stabilization must be completed within 24 hours of connecting to a surface water of the state. The Contractor shall use Method 2 or erosion control blankets when necessary to rapidly stabilize critical areas. Project areas requiring rapid stabilization are defined as those within 200 feet of Unnamed Tributary of the East Branch Rock River. Method 2 consist of applying Type 1 mulch and tacking it with Type 1 hydraulic soil stabilizer at 220 kilograms per hectare (kg/ha) (200 lb/acre).

EXTEND BERM AS OUTLINED

DATE APP'D AND CERT:

SIGNED: R.J. REVERING (ENGINEER) REG. NO. 20711 PH. NO.: 571-2500 M. VELLILLA (ENGINEER) PH. NO.: 571-2500 M.E.V. (DESIGNER) PH. NO.: 571-2500 CHK'D R.R.

D W.O.-11008913

I HEREBY CERTIFY THAT THIS PLAN, SPECIFICATION OR REPORT WAS PREPARED BY ME OR UNDER MY DIRECT SUPERVISION AND THAT I AM A DULY REGISTERED PROFESSIONAL ENGINEER UNDER THE LAWS OF THE STATE OF MINNESOTA

2007 GRADING ADDITION

DATE APP'D AND CERT:

SIGNED: M. METTLER (ENGINEER) REG. NO. 406-656-8100

DATE APP'D:

SIGNED: S. MOHR (DESIGNER) PH. NO.: 406-656-8100

DATE CHK'D



NW 1/4 SEC 6 TOWNSHIP : 106 RANGE : 43 WEST COUNTY : MURRAY

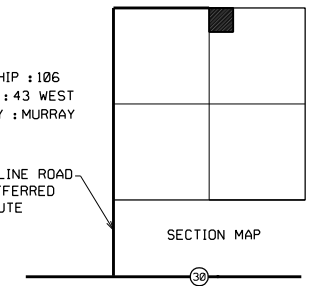

LEGEND

- PROPERTY LINE
--- 890 --- EXISTING CONTOUR LINE
--- 891 --- PROPOSED CONTOUR LINE
P.P. POWER POLE
--- DRAINTILE
--- DRAINAGE DIRECTION
SOIL BORING
CONTROL POINT
SILT FENCE
ROCK CHECK DITCH CHECK

GENERAL NOTES

- 1. LOCATION OF BENCH MARK FOR GRADE ELEVATION IS A RED FENCE POST LOCATED ALONG THE NORTH SIDE OF THE TOWNSHIP ROAD APPROXIMATELY 480 FEET EAST OF THE WEST PROPERTY LINE OF THE SITE ASSUMED ELEVATION OF BENCH MARK IS 1842.84
2. CONTOURS AT ONE FOOT INTERVALS.
3. ELEVATIONS INDICATED IN SUBSTATION GRADED AREA ARE TOP OF MNDOT CLASS 5 OR APPROVED EQUAL.
4. CONTOURS OUTSIDE OF THE SUBSTATION GRADED AREA INDICATE THE TOP OF FINISHED TOPSOIL.
5. FINISHED GRADE IN SUBSTATION GRADED AREA IS 4 INCHES HIGHER THAN THE ROUGH GRADE ELEVATION. FINISHED GRADE CONSISTS OF 4 INCHES OF CRUSHED ROCK PROVIDED AND INSTALLED BY NSP.
6. SITE GRADING SHALL BE PERFORMED IN ACCORDANCE WITH NSP SPEC. 220 "SPECIFICATION FOR SITE GRADING", REV. 3, DATED 7/15/94
7. EROSION CONTROL SHALL BE PERFORMED IN ACCORDANCE WITH NSP SPEC. 221 "SPECIFICATION FOR EROSION CONTROL PLAN", REV. 0, DATED 8/18/95.
8. DIMENSIONS SHOWN FOR TRANSMISSION DEADEND ANCHORS ARE A MINIMUM, SHOULD ANCHORS BE DISTURBED CONSTRUCTION SHALL STOP UNTIL ANCHORS ARE STABILIZED.
9. EXCESS MATERIAL SHALL BE WASTED ON SITE IN THE AREAS AS SHOWN ON PLAN AND SECTION DRAWINGS.

APPROXIMATE EARTHWORK QUANTITIES 2007 CONSTRUCTION

CUT/FILL TABLE with columns for CUT, FILL, TOP SOIL STRIPPING, BALANCE, CLASS V, SELECT FILL, SURFACING and corresponding CY values.

THIS MAP/DOCUMENT IS A TOOL TO ASSIST EMPLOYEES IN THE PERFORMANCE OF THEIR JOBS. YOUR PERSONAL SAFETY IS PROVIDED FOR BY USING SAFETY PRACTICES, PROCEDURES AND EQUIPMENT AS DESCRIBED IN THE SAFETY TRAINING PROGRAMS, MANUALS AND SPARS. ENGINEERING DEPARTMENT MINNEAPOLIS, MN CHANARAMBIE SUBSTATION (CHB) CONTOUR & GRADING LAYOUT SH.1 OF 2 PLAN Xcel Energy SCALE 1"=50' NH-158184-1

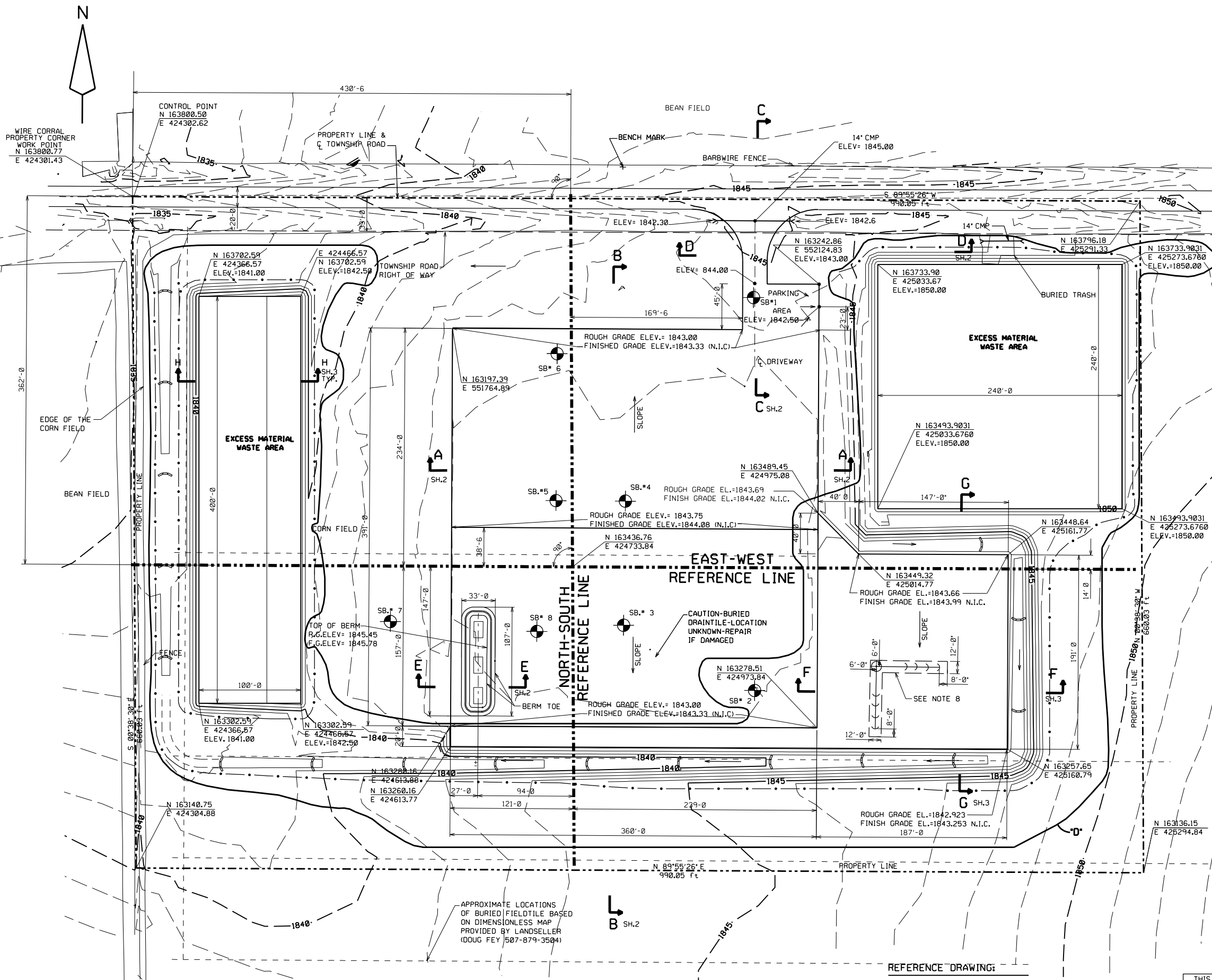

- PROPERTY PLAT
LOCATION PLAN NF-182672
SOIL BORINGS NX-60628-1
TOPOGRAPHY LAYOUT NH-158205
FOUNDATION LAYOUT NH-158224

APPROXIMATE LOCATIONS OF BURIED FIELD TILE BASED ON DIMENSIONLESS MAP PROVIDED BY LANDSELLER (DOUG FEY 507-879-3504)

REFERENCE DRAWING:

PERMANENT EROSION AND SEDIMENT CONTROL BMPS

Clean out sediment from the channels and ditches. Flush outlet pipes clean. Remove any unneeded temporary BMPs within the construction area that shall interfere with permanent BMPs, except perimeter silt fences and as directed by the Engineer/Contractor/Erosion Inspector.

Permanent controls for construction activities shall consist of the following:

- Turf establishment

TURF ESTABLISHMENT

Permanent turf shall be established in the ditches along the perimeter of the substation and on the excess material waste areas. The Contractor shall consult with the landowner for specific seed mixes for reseeding adjacent to agricultural fields. The Contractor shall apply Minnesota Department of Transportation (MnDOT) seed mixture 250 (General Non Prairie) at a rate of 70lbs/ac. Adjacent to agricultural areas, where the land owner has not provided specifications, MnDOT seed mixture 280 at a rate of 50lbs/ac should be used. The following are seeding dates:

- Spring seeding shall be done between April 1 and September 1.
- Dormant seeding shall be done between October 20 and November 15.
- Otherwise, the site shall be temporary seeded, mulched, and maintained until the appropriate season for seeding.

Seed Bed Preparation

Prepare seedbed to a depth of 3 inches. Slopes steeper than 1:2 shall not require loosening as long as the Contractor stabilizes the slopes as they are opened up or created. Soil tests are recommended to determine the appropriate fertilizer analysis and application rate. If a soils test can not be obtained, apply 350 pounds (lb) of 20-10-20 fertilizer per acre and incorporate it into the seedbed.² Roll the area to be seeded with an approved cultipacker.

Mulch and Blanket

The Contractor shall use Type 1 straw mulch at a rate of 2 tons per acre in conjunction with temporary seed mixture on slopes 1:3 or flatter. The mulch shall be disk-anchored or guar gum tackifier shall be used to anchor the straw mulch. For slopes between 1:3 and 1:2, Type 4 mulch shall be used. Category 3 or 4 erosion control blanket shall be used on slopes 1:2 and steeper and in ditch bottoms greater than 2 %.

² District 8 Turf Establishment Recommendation: MN/DOT Technical Memo.

Maintain turf areas until the site has undergone final stabilization, which shall include watering, reseeding, and reapplying mulch as needed. Final stabilization shall be considered as soil disturbing activities have been completed and a uniform perennial vegetation cover with density at least equal to 70 percent of the natural surrounding cover for unpaved areas and areas not covered by permanent structures has been established or equivalent permanent stabilization measures have been employed. Care of turf may extend into the next growing season.

INSPECTIONS AND MAINTENANCE

INSPECTIONS

Periodic inspections should be conducted of temporary erosion and sediment controls at least once every 7 days, within 24 hours of rainfall events that produce more than 0.5 inches of rain in a 24-hour period or greater, or a snowmelt event that cause surface erosion. Where runoff is unlikely due to winter conditions, such inspections shall be conducted at least once per month. Records shall be kept for each inspection and maintenance activity and shall contain the following information:

- Date and time of inspection
- Name of person(s) conducting inspection
- Findings of inspections, including recommendations for corrective action
- Corrective actions taken, including dates, time, and party completing maintenance activities
- Date and amount of all rainfall events that produce more than 0.5 inches of rain in a 24-hour period or greater
- Document changes to SWPPP

An Inspection Log is provided in Appendix D.

MAINTENANCE

It is the Contractor's responsibility to maintain silt fences, and other temporary erosion and sediment controls in working order throughout the project and make repairs as needed. Maintenance shall include the following:

- Sediment trap shall be at 50 percent capacity.
- Excess sediment behind silt fences and biorolls shall be removed and properly disposed when sediments reach one-third the height of the structure.
- Tracked sediments will be removed from paved surfaces at the end of each day.
- Construction entrances shall be maintained daily.

All remaining temporary BMPs and accumulated sediments from silt fences shall be removed 30 days after site has undergone final stabilization.

POLLUTION PREVENTION MANAGEMENT MEASURES

SPILLS CLEAN

Clean up petroleum spills promptly by placing contaminated soils in a drum(s) for proper disposal off-site.

TRASH AND DEBRIS

The Contractor shall keep the work site clean. Do not bury trash and debris within fill or backfill. Collect construction and demolition debris, debris from clearing and grubbing, trash, and other waste at least weekly for disposal off-site. No on-site burning is permitted. Contractor shall comply with federal, state, and local requirements for the disposal of solid waste.

HAZARDOUS MATERIALS

Oils, fuels, and any hazardous substances must be properly stored, including secondary containment for tanks larger than 55 gallons, to prevent spills. Restricted access to storage areas must be provided to prevent vandalism. Storage and disposal of hazardous materials must be in compliance with federal, state, and local regulations.

TRUCK WASHING

If required, a location shall be set aside for washing concrete trucks. Discharge from the wash shall be directed into a sediment trap, which shall also receive waste concrete. The trap shall be cleaned out at least weekly and the material disposed off-site.

DUST CONTROL

The Contractor shall take measures to prevent fugitive dust during the work. This may require periodic wetting of exposed soils and engineered fills until soils are stabilized and pavement is installed.

PERMANENT STORMWATER MANAGEMENT MEASURE

Stormwater from the substation shall be discharged to a perimeter ditch which has sufficient capacity to treat runoff from the site, as required by the MPCA.

PLAN MODIFICATIONS

The SWPPP must accurately reflect the site features and operations. If the Owner or Contractor observes that the plan is not effective in minimizing pollutant discharge from the site, then the SWPPP must be updated or changed. Also, the plan shall be updated to include contractors and subcontractors identified after the submittal of the NOI. These contractors shall certify the plan and be identified as co-permittees (Appendix E).

NOTICE OF TERMINATION

The Owner is required to submit a Notice of Termination (NOT) to the MPCA within 30 days after one or more of the following conditions have been met:

1. Final stabilization has been achieved on all portions of the site for which the Owner is responsible; or
2. Another Owner has assumed control according to Appendix A, Part II.B.5, overall areas of the site that have not been finally stabilized.

A copy of the NOT can be found in Appendix F.



Appendix A
MPCA General Construction Permit – MN R10001

**GENERAL PERMIT
AUTHORIZATION TO DISCHARGE
STORM WATER ASSOCIATED WITH CONSTRUCTION ACTIVITY
UNDER THE NATIONAL POLLUTANT DISCHARGE ELIMINATION
SYSTEM/STATE DISPOSAL SYSTEM PERMIT PROGRAM**

ISSUANCE DATE: August 1, 2003 EXPIRATION DATE: August 1, 2008

In compliance with the provisions of the Clean Water Act, as amended, (33 U.S.C. 1251 et seq.; hereinafter, the "Act"), 40 CFR 122, 123, and 124, as amended, et seq.; Minn. Stat. Chs. 115 and 116, as amended, and Minn. R. Ch. 7001:

This permit regulates the discharges of **storm water** to the **waters of the state** of Minnesota associated with **construction activity**. This permit covers the **storm water** discharges identified in Part I.A. of this permit. The limitations on permit coverage are identified in Part I.B. of this permit.

This permit requires the development and implementation of a **Storm Water Pollution Prevention Plan (SWPPP)**. No person shall commence **construction activity** covered by Part I.A. until permit coverage under this permit is effective or, if applicable, until the Minnesota Pollution Control Agency (MPCA) has issued an individual NPDES/SDS construction **storm water** permit for the project. The **SWPPP** must be completed prior to submitting any permit application and prior to conducting any **construction activity** by any required **Permittee**.

Unless notified by the MPCA to the contrary, applicants who submit a completed application (including permit fee) in accordance with the requirements of this permit are authorized to discharge **storm water** from construction sites under the terms and conditions of this permit 7, 30, or 90 days after the postmarked date of the completed application as described in Part II.B.

Coverage under this permit will remain in effect until the **owner** has submitted a **Notice of Termination**, regardless of the above expiration date.

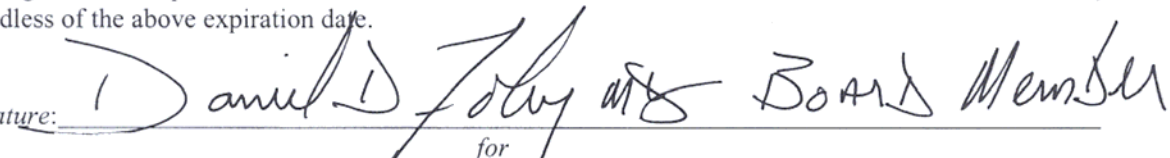
Signature: 
for
Minnesota Pollution Control Agency

If you have questions on this permit, including the specific permit requirements, permit reporting or permit compliance status, please contact the appropriate MPCA offices.

**Minnesota Pollution Control Agency
Construction Storm Water Program
520 Lafayette Road North
St. Paul, MN 55155-4194
Telephone (651) 297-2274**

Table of Contents

Page

- I. PERMIT COVERAGE AND LIMITATIONS..... 3**
 - A. Permit Coverage 3
 - B. Limitations of Coverage..... 3

- II. SUBMITTING THE APPLICATION 4**
 - A. Prerequisite for Submitting a Permit Application 4
 - B. Application and Duration of Coverage..... 4
 - C. Termination of Coverage..... 6

- III. STORM WATER DISCHARGE DESIGN REQUIREMENTS..... 7**
 - A. Storm Water Pollution Prevention Plan 7
 - B. Temporary Sediment Basins 9
 - C. Permanent Storm Water Management System..... 10
 - D. Record Retention..... 13

- IV. CONSTRUCTION ACTIVITY REQUIREMENTS 13**
 - A. Storm Water Pollution Prevention Plan 13
 - B. Erosion Prevention Practices 13
 - C. Sediment Control Practices 14
 - D. Dewatering and Basin Draining 15
 - E. Inspections and Maintenance 15
 - F. Pollution Prevention Management Measures 17
 - G. Final Stabilization..... 17

- V. GENERAL PROVISIONS 18**
 - A. Applicability Criteria..... 18
 - B. Response..... 18
 - C. Prohibitions 18
 - D. Transfer of Ownership or Control 18
 - E. Civil and Criminal Liability 18
 - F. Severability..... 19
 - G. NPDES/SDS Rule Standard Conditions..... 19
 - H. Inspection and Entry 19

- APPENDIX A 19**

- APPENDIX B - DEFINITIONS 23**

PART I. PERMIT COVERAGE AND LIMITATIONS

A. PERMIT COVERAGE

1. This permit is required for **storm water** discharges associated with **construction activity** and with **small construction activity** as defined in 40 C.F.R. part 122.26(b)(14)(x) and (b)(15), respectively.
2. This permit authorizes, subject to the terms and conditions of this permit, the discharge of **storm water** associated with **construction activity** and **small construction activity**.

Construction activity includes clearing, grading and excavation, that disturbs land of equal to or greater than five (5) acres and includes the disturbance of less than five (5) acres of total land area that is a part of a larger **common plan of development or sale** if the larger common plan will ultimately disturb five (5) acres or more.

Small construction activity includes clearing, grading and excavation, that disturbs land of equal to or greater than one (1) acre, and includes the disturbance of less than one (1) acre of total land area that is part of a larger **common plan of development or sale** if the larger common plan will ultimately disturb equal to or greater than one and less than five (5) acres. **Small construction activity** does not include routine maintenance that is performed to maintain the original line and grade, hydraulic capacity, or original purpose of the facility.

3. This permit covers all areas of the state of Minnesota.
4. For Parts I.B through Appendix A of this permit, all reference to **construction activity** includes both **small construction activity** and **construction activity**.

B. LIMITATIONS OF COVERAGE

This permit does not cover the following activities:

1. Discharges or releases that are not **storm water** except those non-**storm water** discharges authorized under Part IV.D.
2. The placement of fill into **waters of the state** requiring local, state, or federal authorizations (such as U.S. Army Corps of Engineers Section 404 permits, Department of Natural Resources Public Waters Work Permits or Local Governmental Unit Wetland Conservation Act replacement plans or determinations).
3. **Storm water** discharges associated with industrial activity that originate from the site after construction activities have been completed and the site has undergone **final stabilization**. Post-construction industrial **storm water** discharges may need to be covered by a separate NPDES/SDS permit.
4. Non-point source agricultural and silvicultural discharges excluded from **NPDES** permit requirements under 40 CFR part 122.3(e).
5. **Discharges** to the waters identified below unless the requirements of Appendix A. are complied with:

- a. Discharges into outstanding resource value waters (ORVWs) as defined in Minn. R. 7050.0180, subp. 3 and 6, except calcareous fens listed in Minn. R. 7050.0180, subp. 6.b.
 - b. Discharges into Trout waters as listed in Minn. R. 6264.0050, subp. 2 and 4.
 - c. Discharges into **Wetlands** as listed in Minn. R. 7050.0130, item. F.
 - d. Discharges from projects that have not met applicable Environmental Review requirements under state or federal laws.
 - e. Discharges that adversely impact or contribute to adverse impacts on a listed endangered or threatened species or adversely modify a designated critical habitat.
 - f. Discharges which adversely affect properties listed or eligible for listing in the National Register of Historic Places or affecting known or discovered archeological sites.
6. Discharges to calcareous fens listed in Minn. R. 7050.0180, subp. 6.b.
 7. Discharges to waters for which there is a total maximum daily load (TMDL) allocation for sediment and parameters associated with sediment transport are not eligible for coverage under this permit unless the **Permittee(s)** develop and certify a **SWPPP** that is consistent with the assumptions, allocations and requirements in the approved TMDL. To be eligible for coverage under this general permit, **Permittee(s)** must incorporate into their **SWPPP** any conditions applicable to their discharges necessary for consistency with the assumptions, allocations and requirements of the TMDL within any timeframes established in the TMDL. The **SWPPP** must include the provisions in Part III.A.7. If a specific numeric wasteload allocation has been established that would apply to the project's discharges, the **Permittee(s)** must incorporate that allocation into its **SWPPP** and implement necessary steps to meet that allocation.

PART II. SUBMITTING THE APPLICATION

A. PREREQUISITE FOR SUBMITTING A PERMIT APPLICATION

The **owner** must develop a **Storm Water Pollution Prevention Plan (SWPPP)** in accordance with Part III (Storm Water Discharge Design Requirements) of this permit. The plans are not to be submitted to the MPCA (unless the project size is 50 acres or more and will discharge to certain waters as described in Part II.B.1.b.) but are to be retained by the **owner** in accordance with Part III.D (Record Retention). The applicants' failure to complete the **SWPPP** prior to submitting the application will result in the application being returned and the **storm water** discharges associated with **construction activity** will not be authorized by this permit.

B. APPLICATION AND DURATION OF COVERAGE

1. Application Required.

- a. The **owner** and **operator** shall submit a completed application form (or a photocopy thereof) with the appropriate fee for project size (see application form) to the MPCA for each project which disturbs one (1) or more acres of land. The **owner** and **operator** of a **common plan**

- of development or sale** that will ultimately disturb one (1) or more acres must submit a completed application to the MPCA.
- b. For certain projects or **common plans of development or sale** disturbing 50 acres or more, the application must be submitted at least 30 days before the start of construction activity. This requirement pertains to projects that have a discharge point on the project that is within 2000 feet of, and flows to, a special water listed in Appendix A, Part B. or waters listed as impaired under section 303(d) of the federal Clean Water Act (see MPCA's web site). Applicants must submit a completed application form and **Storm Water Pollution Prevention Plan** including all calculations for the Permanent Storm Water Management System (see Part III.A – C).
2. The **Owner** and **Operator** are **Permittee(s)**. The **owner** who signs the application is a **Permittee** and is responsible for compliance with all terms and conditions of this permit. The **operator** (usually the **general contractor**) who signs the application is a **Permittee** for Parts II.B., Part II.C. and Part IV. of this permit and is jointly responsible with the **owner** for compliance with those portions of the permit.
 3. Permit Coverage. The commencement of any **construction activity** (e.g., land disturbing activities) covered under Part I.A. of this permit is prohibited until permit coverage under this permit is effective or, if applicable, until the MPCA has issued an individual NPDES/SDS construction **storm water** permit for the project.
 - a. Except as provided in subp. 3.b. and 3.c. below, permit coverage will become effective seven (7) days after the postmarked date of the completed application form.
 - b. For projects disturbing 50 acres or more, that have a discharge point on the project that is within 2000 feet of, and flows to, a special water listed in Appendix A, Part B. or waters listed as impaired under section 303(d) of the federal Clean Water Act, the applicants must submit a completed application and **SWPPP** to the MPCA at least thirty (30) days prior to the commencement of construction activities. MPCA staff will review the **SWPPP** submitted with the completed application and unless the **Permittee** is notified in writing that the **SWPPP** does not meet the general permit requirements, permit coverage will become effective 30 days after the postmarked date or MPCA date-stamp (whichever is first) of the completed application.
 - c. For proposals to use Alternative Method(s) for the Permanent Storm Water Management System under Part III.C.5, the applicants must submit a completed application and **SWPPP**, including the Alternative Method documentation under Part III.C.5, to MPCA for review and approval at least 90 days prior to the proposed starting date of **construction activity**.
 - i. The MPCA will notify the applicant within the 90-day period, in writing, whether the alternative method is approved or not approved and, if applicable, the basis for denial.
 - ii. The applicant may re-submit the alternative method after addressing the MPCA's basis for denial. The MPCA will respond within 30 days.
 - iii. Permit coverage will become effective upon receipt of an alternative treatment method approval letter from MPCA. Any **construction activity** on the project is not covered under this permit until receiving the alternative treatment approval letter.

4. Coverage Letter. For projects under subpart 3.a. of this part, the **Permittee(s)** will receive a permit letter and certificate acknowledging permit coverage, usually within 30 days of the postmarked date of the completed application.
5. Change of Coverage. For **storm water** discharges from construction projects where the **owner** or **operator** changes, (e.g., an original developer sells portions of the property to various homebuilders) the new **owner** or **operator** must submit a subdivision registration within 7 days of assuming operational control of the site, commencing work on their portion of the site, or of the legal transfer, sale or closing on the property. For instances where an **owner** or **operator** of an entire project changes after an application has been submitted under Part II, the new **owner** or **operator** must submit an application for permit transfer/modification within 7 days of assuming control of the site or commencing work on-site, or of the legal transfer, sale or closing on the property. Late submittals will not be rejected; however, the MPCA reserves the right to take enforcement for any unpermitted discharges or permit noncompliance for the new registered party that has assumed control of the site. For **storm water** discharges from construction activities where the **owner** or **operator** changes, the new **owner** or **operator** can implement the original **SWPPP** created for the project or develop and implement their own **SWPPP**. **Permittee(s)** shall ensure either directly or through coordination with other **Permittee(s)** that their **SWPPP** meets all terms and conditions of this permit and that their activities do not render another party's **erosion prevention** and **sediment control Best Management Practices (BMPs)**."

C. TERMINATION OF COVERAGE

1. **Permittee(s)** wishing to terminate coverage under this permit must submit a **Notice of Termination (NOT)** to the MPCA. Compliance with this permit is required until a **NOT** is submitted. The **Permittee(s)** authorization to discharge under this permit terminates at midnight of the day the **NOT** is signed.
2. All **Permittee(s)** must submit a **NOT** within thirty (30) days after one or more of the following conditions have been met:
 - a. **Final stabilization** (see Part IV.G. and definition in Appendix B) has been achieved on all portions of the site for which the **Permittee** is responsible (including the removal of all temporary measures such as silt fence, and if applicable, returning agricultural land to its pre-construction agricultural use);
 - b. Another **owner/operator (Permittee)** has assumed control according to Part II.B.5 over all areas of the site that have not been finally **stabilized**; or
 - c. For residential construction only, **temporary erosion protection** and down gradient perimeter control for individual lots has been completed and the residence has been transferred to the homeowner. Additionally, the **Permittee** must distribute the MPCA's "**homeowner factsheet**" to the homeowner to inform the homeowner of the need for, and benefits of, **final stabilization**.
3. **Permittee(s)** that use an alternative method for the permanent **storm water** management system as described in Part III.C.5, are prohibited from terminating this permit until final stabilization has been achieved on site and either:

- a) The two years of monitoring data has been submitted to the MPCA and the MPCA has determined that the required treatment has been achieved. The Permittee will be notified in writing within 30 days after the monitoring data has been submitted. If the Permittee has not heard from the MPCA within 30 days after submitting the required data, the Permittee can submit a **Notice of Termination**.
- b) The Permittee can submit a **Notice of Termination**, even if the timeframe is less than two years, if the MPCA determines that the alternative method is achieving the required treatment.

During the monitoring and evaluation of the alternative method, the **Permittee** is not responsible for other permit requirements that have been transferred as described in Part II.B.5.

PART III. STORM WATER DISCHARGE DESIGN REQUIREMENTS

A. STORM WATER POLLUTION PREVENTION PLAN

The **owner** must develop a **Storm Water Pollution Prevention Plan (SWPPP)**. The **SWPPP** shall be completed prior to submitting any permit application and prior to conducting any **construction activity** by any required **Permittee(s)**. The plan must be a combination of narrative, plan sheets and if appropriate standard detail sheets that address the foreseeable conditions, at any stage in the construction or post construction activities. The plan must include a description of the nature of the **construction activity**. The plan must address the potential for discharge of sediment and/or other potential pollutants from the site. For **storm water** discharges from construction activities where the **owner** or **operator** changes, the new **owner** or **operator** can implement the original **SWPPP** created for the project or develop and implement their own **SWPPP**. **Permittee(s)** shall ensure either directly or through coordination with other **Permittee(s)** that their **SWPPP** meets all terms and conditions of this permit and that their activities do not render another party's **erosion prevention** and **sediment control Best Management Practices (BMPs)** ineffective.

1. As part of the **SWPPP** the **owner** must identify a person knowledgeable and experienced in the application of **erosion prevention** and **sediment control BMPs** who will oversee the implementation of the **SWPPP**, and the installation, inspection and maintenance of the **erosion prevention** and **sediment control BMPs** before and during construction. The **owner** must identify who will have the responsibility for long term operation and maintenance of the permanent **storm water** management system (see Part III.C.). The **owner** shall develop a chain of responsibility with all **operators** on the site to ensure that the **SWPPP** will be implemented and stay in effect until the construction project is complete, the entire site has undergone **final stabilization**, and a **NOT** has been submitted to the MPCA.
2. The **SWPPP** must incorporate the requirements of Part III (Storm Water Discharge Design Requirements), Part IV (Construction Activity Requirements) and Appendix A for the project. A narrative describing the timing for installation of all **erosion prevention** and **sediment control BMPs** required in Part III, Part IV and Appendix A must also be included in the plan.
3. The **SWPPP** requirements must be incorporated into the project's final plans and specifications and/or project documentation, as appropriate, and must include:
 - a. Location and type of all temporary and permanent **erosion prevention** and **sediment control BMPs** along with procedures to be used to establish additional temporary **BMPs** as necessary

for the site conditions during construction. **Standard plates** and/or specifications for the **BMPs** used on the project must be included in the final plans and specifications for the project.

- b. A site map with existing and final grades, including dividing lines and direction of flow for all pre and post-construction **storm water** runoff drainage areas located within the project limits. The site map must also include **impervious surfaces** and soil types.
 - c. Locations of areas not to be disturbed.
 - d. Location of areas where construction will be phased to minimize duration of exposed soil areas.
 - e. All **surface waters** and existing **wetlands**, which can be identified on maps such as United States Geological Survey 7.5 minute quadrangle maps or equivalent maps within one-half mile from the project boundaries, which will receive **storm water** runoff from the construction site, during or after construction. Where **surface waters** receiving runoff associated with **construction activity** will not fit on the plan sheet, they must be identified with an arrow, indicating both direction and distance to the **surface water**.
 - f. Methods to be used for **final stabilization** of all exposed soil areas.
4. The **Permittee(s)** must amend the **SWPPP** as necessary to include additional requirements, such as additional or modified **BMPs**, designed to correct problems identified or address situations whenever:
- a. There is a change in design, construction, operation, maintenance, weather or seasonal conditions that has a significant effect on the discharge of pollutants to **surface waters** or **underground waters**;
 - b. Inspections or investigations by site **operators**, local, state or federal officials indicate the **SWPPP** is not effective in eliminating or significantly minimizing the discharge of pollutants to **surface waters** or **underground waters** or that the discharges are causing water quality standard exceedances; or
 - c. The **SWPPP** is not achieving the general objectives of controlling pollutants in **storm water** discharges associated with **construction activity**, or the **SWPPP** is not consistent with the terms and conditions of this permit.
 - d. At any time after permit coverage is effective, the MPCA may determine that the project's **storm water** discharges may cause, have reasonable potential to cause, or contribute to non-attainment of any applicable water quality standard, or that the **SWPPP** does not incorporate the requirements in Part III.A.7 related to an approved Total Maximum Daily Load (TMDL) implementation plan that contains construction **storm water** related requirements. If MPCA makes such determination(s) or any of the determinations in Parts III.A.4.a.-4.c., MPCA will notify the **Permittees** in writing. In response, the **Permittees** must develop a supplemental **BMP** action plan or appropriate **SWPPP** amendments describing **SWPPP** modifications to address the identified concerns and submit information requested by MPCA, which may include

- an individual permit application. If MPCA's written notification requires a response, failure to respond within the specified timeframe constitutes a permit violation.
5. The **SWPPP** must factor in any findings of and include any **storm water** mitigation measures required as the result of any environmental, archeological or other required local, state or federal review conducted for the project. For the purposes of this permit provision, mitigation measures mean avoiding, minimizing, rectifying (e.g., repairing, rehabilitating, restoring), reducing, eliminating or compensating for impacts related to: (1) **storm water** discharges associated with the project's **construction activity**; and (2) **erosion prevention, sediment control** and the permanent **storm water** management system for the project.
 6. The **SWPPP** must provide additional measures as necessary to assure compliance with surface and ground water standards in Minn. R. chapters 7050 and 7060 in karst areas and to ensure protection of drinking water supply management areas (see Minn. R. 4725.4450).
 7. If runoff from the site discharges to an impaired water which has an approved TMDL implementation plan containing requirements for construction **storm water** discharges, the **Permittee** must include the following in the SWPPP:
 - a. identify the receiving water and the areas of the site discharging to it; and
 - b. BMPs that are appropriate for the site and sufficient to comply with all applicable requirements of the TMDL implementation plan.

B. TEMPORARY SEDIMENT BASINS

Where ten (10) or more acres of disturbed soil drain to a common location, a temporary (or permanent) sediment basin must be provided prior to the runoff leaving the construction site or entering **surface waters**. The **Permittee** is encouraged, but not required, to install temporary sediment basins where appropriate in areas with steep slopes or highly erodible soils even if less than ten (10) acres drains to one area. The basins must be designed and constructed according to the following requirements:

1. The basins must provide storage below the outlet pipe for a calculated volume of runoff from a 2 year, 24 hour storm from each acre drained to the basin, except that in no case shall the basin provide less than 1800 cubic feet of storage below the outlet pipe from each acre drained to the basin.
2. Where no such calculation has been performed, a temporary (or permanent) sediment basin providing 3,600 cubic feet of storage below the outlet pipe per acre drained to the basin, shall be provided where attainable until **final stabilization** of the site.
3. Temporary basin outlets must be designed to prevent short-circuiting and the discharge of floating debris. The basin must be designed with the ability to allow complete basin drawdown (e.g., perforated riser pipe wrapped with filter fabric and covered with crushed gravel, pumps or other means, see Part IV.D.) for maintenance activities, and provide a **stabilized** emergency overflow to prevent failure of pond integrity. **Energy dissipation** must be provided for the basin outlet (see Part IV.B.4).

4. The temporary (or permanent) basins must be constructed and made operational concurrent with the start of soil disturbance that is upgradient of the area and contributes runoff to the pond.
5. Where the temporary sediment basin is not attainable due to site limitations, equivalent **sediment controls** such as smaller sediment basins, and/or sediment traps, silt fences, vegetative buffer strips, or any appropriate combination of measures are required for all down slope boundaries of the construction area and for those side slope boundaries deemed appropriate as dictated by individual site conditions. In determining whether installing a sediment basin is attainable, the **Permittee** must consider public safety and may consider factors such as site soils, slope, and available area on site. This determination must be documented in the **SWPPP**.

C. PERMANENT STORM WATER MANAGEMENT SYSTEM

All **storm water** must be discharged in a manner that does not cause nuisance conditions, erosion in receiving channels or on downslope properties, or inundation in **wetlands** causing a significant adverse impact to the wetlands.

Where a project's ultimate development replaces vegetation and/or other pervious surfaces with one or more acres of cumulative **impervious surface**, a **water quality volume** of ½ inch of runoff from the new **impervious surfaces** created by the project must be treated by one of the methods outlined in Part III.C.1 through Part III.C.5 prior to the runoff leaving the construction site or entering **surface waters** (excluding drainage systems that convey **storm water** to a constructed permanent **storm water** management facility designed to treat the **water quality volume** from the project).

For those areas of a project where there is no feasible way to meet the treatment requirement for the **water quality volume**, other treatment such as grassed swales, smaller ponds or grit chambers is required prior to discharge to **surface waters**. A cumulative maximum of (3) three acres or 1% of project size whichever is larger can be treated in this manner.

Where the proximity to bedrock precludes the installation of any of the permanent **storm water** management practices outlined in Part III.C., other treatment, such as grassed swales, smaller ponds, or grit chambers, is required prior to discharge to **surface waters**.

For work on road projects where the lack of right of way precludes the installation of any of the permanent **storm water** management practices outlined in Part III.C., other treatment such as grassed swales, smaller ponds, or grit chambers, is required prior to discharge to **surface waters**.

1. Wet Sedimentation Basin

- a. The basin must have a permanent volume of 1800 cubic feet of storage below the outlet pipe for each acre that drains to the basin. The basin's permanent volume must reach a minimum depth of at least 3 feet and must have no depth greater than 10 feet. The basin must be configured such that scour or resuspension of solids is minimized.
- b. The basin's **water quality volume** is calculated as ½ inch of runoff from the new **impervious surfaces** created by the project.
- c. Basin outlets shall be designed such that the **water quality volume** is discharged at no more than 5.66 cubic feet per second (cfs) per acre of surface area of the pond.

- d. Basin outlets must be designed to prevent short-circuiting and the discharge of floating debris. Basin outlets must have **energy dissipation**.
- e. The basin must provide a **stabilized** emergency overflow to accommodate storm events in excess of the basin's hydraulic design.
- f. Adequate maintenance access must be provided (typically 8 ft. wide) for future maintenance of the basin.

2. Infiltration/Filtration

Infiltration/Filtration options include but are not limited to: infiltration basins, infiltration trenches, rainwater gardens, sand filters, organic filters, bioretention areas, enhanced swales, dry storage ponds with underdrain discharge, off-line retention areas and natural depressions. Infiltration must be used only as appropriate to the site and land uses. Settleable solids, floating materials, oils and grease should be removed from the runoff to the maximum extent practicable before runoff enters the infiltration/filtration system. Filtration systems must have a reasonable chance of achieving approximately 80% removal of total suspended solids. The **Permittee(s)** must evaluate the impact of constructing an infiltration practice on existing hydrologic features (e.g., existing **wetlands**) and try to maintain pre-existing conditions (e.g., do not breach a perched water table which is supporting a **wetland**). For a discussion of ground water warnings, design measures, maintenance considerations or other retention, detention, and treatment devices, see the MPCA's **Protecting Water Quality in Urban Areas** found on the MPCA's web-site.

- a. Infiltration systems should not be excavated to final grade until the contributing drainage area has been constructed and fully **stabilized**.
- b. During construction of an infiltration system, rigorous sediment and erosion controls (e.g., diversion berms) should be used to keep sediment and runoff completely away from the infiltration area. The area must be staked off and marked so that heavy construction equipment will not compact the soil in the proposed infiltration area.
- c. To prevent clogging of the infiltration or filtration system, a pretreatment device such as a vegetated filter strip, small sedimentation basin, or water quality inlet (e.g., grit chamber) must be used to settle particulates before the **storm water** discharges into the infiltration or filtration system.
- d. Infiltration or filtration systems shall be sufficient to infiltrate or filter a **water quality volume** of ½ inch of runoff from the new **impervious surfaces** created by the project.
- e. The **water quality volume** shall discharge through the soil or filter media in 48 hours or less. Additional flows that cannot be infiltrated or filtered in 48 hours should be routed to bypass the system through a **stabilized** discharge point. A way to visually verify that the system is operating as designed must be provided.
- f. Appropriate on-site testing shall be conducted to ensure a minimum of 3 feet of separation from the seasonally **saturated soils** (or from bedrock) and the bottom of the proposed infiltration system. Calculations and computer model results that demonstrate the design adequacy of the infiltration system must be included as part of the **SWPPP**.

- g. Adequate maintenance access must be provided (typically 8 ft. wide) along with a maintenance plan identifying whom will be performing future maintenance of the infiltration or filtration system.
- h. Use of designed infiltration systems from industrial areas with exposed significant materials or from vehicle fueling and maintenance areas is prohibited.

3. Regional Ponds

Regional ponds can be used provided that they are constructed ponds, not a natural **wetland** or waterbody, (**wetlands** used as regional ponds must be mitigated for, see Appendix A) and designed in accordance with this permit's design requirements (see Part III.C.1) for all water from **impervious surfaces** that reach the pond. **Permittees** shall not construct regional ponds in **wetlands**, regardless of their condition, quality or designation by local plans, unless the mitigative sequence in Appendix A. D.2 of this permit has been completed. There must be no significant degradation of the waterways between the project and the regional pond. The **owner** must obtain written authorization from the applicable local governmental unit (LGU) or private entity that owns and maintains the regional pond. The LGU's or private entity's written authorization must identify that the regional pond will discharge the **water quality volume** (½ inch of runoff from the impervious watershed area) at no more than 5.66 cfs per acre of surface area of the pond. The **owner** must include the LGU's or private entity's written authorization in the **SWPPP**. The LGU's or private entity's written authorization must be obtained before the **owner** finalizes the **SWPPP** and before any application for this permit is made to the MPCA.

4. Combination of Practices

A combination of practices, including those required by a LGU, which meet the requirements of Part III.C.1, 2 and 3 respectively, (i.e., wet sedimentation basins, infiltration/filtration, and regional ponds) may be used such that the **water quality volume** of ½ inch of runoff from the new **impervious surfaces** created by the project is accounted for in the **owner's** permanent **storm water** management system (e.g., ¼ inch infiltrated and ¼ inch treated through a wet sedimentation basin). If any combination of these practices is used, the **SWPPP** must contain documentation (e.g., LGU or private entity's authorization, infiltration computer model results or calculations, etc.) identifying the volume that each practice addresses.

5. Alternative Method

Where an alternative, innovative treatment system is proposed and demonstrated by calculation, design or other independent methods to achieve approximately 80% removal of total suspended solids on an annual average basis, the **Commissioner** will approve the method if the process outlined in Part II.B.3.c. is completed, and the following information is submitted:

- a. All calculations, drainage areas, plans, and specifications for the proposed alternative method and a graphic representation of the area to be served by the method. These items must be included in the **SWPPP** and submitted to the MPCA at least 90 days prior to the proposed starting date of the **construction activity**.
- b. A 2 year monitoring plan to sample runoff from the proposed method. The plan must include a discussion of the methods used to collect samples, location where samples will be taken (upstream and downstream of the proposed method), frequency of samples (minimum of six

runoff events sampled), identify lab used to analyze the samples and quality assurance and quality control methods to be used. The plan must include a schedule for submitting the monitoring data annually.

- c. A mitigation plan that addresses how the **water quality volume** will be treated in the event that the monitoring data shows the proposed alternative treatment method does not function as designed.
- d. The alternative method must achieve approximately 80% removal of total suspended solids on an average annual basis for the conditions expected at the site. The design must also consider public safety, health and water quality concerns. Proprietary information on effectiveness will not be considered for alternative treatment method review and approval.

No **construction activity** on the project is covered under this permit until the applicant receives an alternative treatment approval letter from the MPCA as described in Part II.B.3.c.

D. RECORD RETENTION

The **SWPPP**, all changes to it, and inspections and maintenance records must be kept at the site during construction by the **Permittee** who has operational control of that portion of the site. The **SWPPP** can be kept in either the field office or in an on site vehicle.

All **owner(s)** must keep the **SWPPP**, along with the following additional records, on file for three years after submittal of the **NOT** as outlined in Part II.C. This does not include any records after submittal of the **NOT**.

1. Any other permits required for the project;
2. Records of all inspection and maintenance conducted during construction (see Part IV.E. Inspections and Maintenance);
3. All permanent operation and maintenance agreements that have been implemented, including all right of way, contracts, covenants and other binding requirements regarding perpetual maintenance; and
4. All required calculations for design of the temporary and permanent **storm water** management systems.

PART IV. CONSTRUCTION ACTIVITY REQUIREMENTS

A. STORM WATER POLLUTION PREVENTION PLAN

The **Permittee(s)** must implement the **SWPPP** and the requirements of this part. The **Best Management Practices (BMPs)** identified in the **SWPPP** and in this permit must be installed in an appropriate and functional manner.

B. EROSION PREVENTION PRACTICES

1. The **Permittee(s)** must plan for and implement appropriate construction phasing, vegetative buffer strips, horizontal slope grading, and other construction practices that minimize erosion, so

that the inspection and maintenance requirements of Part IV.E. are complied with. The location of areas not to be disturbed must be delineated (e.g. with flags, stakes, signs, silt fence etc.) on the development site before work begins.

2. All exposed soil areas with a continuous positive slope within 200 lineal feet of a **surface water**, must have **temporary erosion protection** or **permanent cover** for the exposed soil areas year round, according to the following table of slopes and time frames:

<u>Type of Slope</u>	<u>Time</u>	(Maximum time an area can remain open when the area is not actively being worked.)
Steeper than 3:1	7 days	
10:1 to 3:1	14 days	
Flatter than 10:1	21 days	

These areas include constructed **storm water** management pond side slopes, and any exposed soil areas with a positive slope to a **storm water** conveyance system, such as a curb and gutter system, storm sewer inlet, temporary or permanent drainage ditch or other natural or man made systems that discharge to a **surface water**. Temporary stockpiles without significant silt, clay or organic components (e.g., clean aggregate stockpiles, demolition concrete stockpiles, sand stockpiles) are exempt from this requirement but must comply with Part IV.C.5.

3. The **normal wetted perimeter** of any temporary or permanent drainage ditch that drains water from a construction site, or diverts water around a site, must be **stabilized** within 200 lineal feet from the property edge, or from the point of discharge to any **surface water**. Stabilization must be completed within 24 hours of connecting to a **surface water**.
4. Pipe outlets must be provided with temporary or permanent **energy dissipation** within 24 hours of connection to a **surface water**.

C. SEDIMENT CONTROL PRACTICES

1. **Sediment control** practices must minimize sediment from entering **surface waters**, including curb and gutter systems and storm sewer inlets.
 - a. Temporary or permanent drainage ditches and sediment basins that are designed as part of a treatment system (e.g., ditches with rock check dams) require **sediment control** practices only as appropriate for site conditions.
 - b. If the down gradient treatment system is overloaded, additional upgradient **sediment control** practices must be installed to eliminate the overloading, and the **SWPPP** must be amended to identify these additional practices as required in Part III.A.4, a. through c.
 - c. In order to maintain sheet flow and minimize rills and/or gullies, there shall be no unbroken slope length of greater than 75 feet for slopes with a grade of 3:1 or steeper.
2. **Sediment control** practices must be established on all down gradient perimeters before any upgradient land disturbing activities begin. These practices shall remain in place until **final stabilization** has been established in accordance with Part IV.G.

3. The timing of the installation of **sediment control** practices may be adjusted to accommodate short-term activities such as clearing or grubbing, or passage of vehicles. Any short-term activity must be completed as quickly as possible and the **sediment control** practices must be installed immediately after the activity is completed. However, **sediment control** practices must be installed before the next precipitation event even if the activity is not complete.
4. All storm drain inlets must be protected by appropriate **BMPs** during construction until all sources with potential for discharging to the inlet have been **stabilized**.
5. Temporary soil stockpiles must have silt fence or other effective **sediment controls**, and cannot be placed in **surface waters**, including **storm water** conveyances such as curb and gutter systems, or conduits and ditches.
6. Vehicle tracking of sediment from the construction site must be minimized by **BMPs** such as stone pads, concrete or steel wash racks, or equivalent systems. Street sweeping must be used if such **BMPs** are not adequate to prevent sediment from being tracked onto the street (see Part IV.E.4.d.).
7. The **Permittee** must install temporary sedimentation basins as required in Part III.B. of this permit.

D. DEWATERING AND BASIN DRAINING

1. **Dewatering** or basin draining (e.g., pumped discharges, trench/ditch cuts for drainage) related to the **construction activity** that may have turbid or sediment laden discharge water must be discharged to a temporary or permanent sedimentation basin on the project site whenever possible. If the water cannot be discharged to a sedimentation basin prior to entering the **surface water**, it must be treated with the appropriate **BMPs**, such that the discharge does not adversely affect the receiving water or downstream landowners. The **Permittee(s)** must ensure that discharge points are adequately protected from erosion and scour. The discharge must be dispersed over natural rock riprap, sand bags, plastic sheeting or other accepted **energy dissipation** measures. Adequate sedimentation control measures are required for discharge water that contains suspended solids.
2. All water from **dewatering** or basin draining activities must be discharged in a manner that does not cause nuisance conditions, erosion in receiving channels or on downslope properties, or inundation in **wetlands** causing significant adverse impact to the **wetland**.

E. INSPECTIONS AND MAINTENANCE

1. The **Permittee(s)** (either the **owner** or **operator**, whoever is identified in the **SWPPP**) must routinely inspect the construction site once every seven (7) days during active construction and within 24 hours after a rainfall event greater than 0.5 inches in 24 hours.
2. All inspections and maintenance conducted during construction must be recorded in writing and these records must be retained with the **SWPPP** in accordance with Part III.D. Records of each inspection and maintenance activity shall include:
 - a. Date and time of inspections;

- b. Name of person(s) conducting inspections;
 - c. Findings of inspections, including recommendations for corrective actions;
 - d. Corrective actions taken (including dates, times, and party completing maintenance activities);
 - e. Date and amount of all rainfall events greater than 1/2 inch (0.5 inches) in 24 hours; and
 - f. Documentation of changes made to the **SWPPP** as required in Part III.A.4.
3. Where parts of the construction site have undergone **final stabilization**, but work remains on other parts of the site, inspections of the **stabilized** areas may be reduced to once per month. Where work has been suspended due to frozen ground conditions, the required inspections and maintenance must take place as soon as runoff occurs at the site or prior to resuming construction, whichever comes first.
4. All **erosion prevention** and **sediment control BMPs** must be inspected to ensure integrity and effectiveness. All nonfunctional **BMPs** must be repaired, replaced, or supplemented with functional **BMPs**. The **Permittee(s)** must investigate and comply with the following inspection and maintenance requirements:
- a. All silt fences must be repaired, replaced, or supplemented when they become nonfunctional or the sediment reaches 1/3 of the height of the fence. These repairs must be made within 24 hours of discovery, or as soon as field conditions allow access.
 - b. Temporary and permanent sedimentation basins must be drained and the sediment removed when the depth of sediment collected in the basin reaches 1/2 the storage volume. Drainage and removal must be completed within 72 hours of discovery, or as soon as field conditions allow access (see Part IV.D.).
 - c. **Surface waters**, including drainage ditches and conveyance systems, must be inspected for evidence of sediment being deposited by erosion. The **Permittee(s)** must remove all deltas and sediment deposited in **surface waters**, including drainage ways, catch basins, and other drainage systems, and restabilize the areas where sediment removal results in exposed soil. The removal and stabilization must take place within seven (7) days of discovery unless precluded by legal, regulatory, or physical access constraints. The **Permittee** shall use all reasonable efforts to obtain access. If precluded, removal and stabilization must take place within seven (7) calendar days of obtaining access. The **Permittee** is responsible for contacting all local, regional, state and federal authorities and receiving any applicable permits, prior to conducting any work.
 - d. Construction site vehicle exit locations must be inspected for evidence of off-site sediment tracking onto paved surfaces. Tracked sediment must be removed from all off-site paved surfaces, within 24 hours of discovery, or if applicable, within a shorter time to comply with Part IV.C.6.
 - e. The **Permittee(s)** are responsible for the operation and maintenance of temporary and permanent water quality management **BMPs**, as well as all **erosion prevention** and **sediment control BMPs**, for the duration of the construction work at the site. The

Permittee(s) are responsible until another **Permittee** has assumed control according to Part II.B.5 over all areas of the site that have not been finally **stabilized** or the site has undergone **final stabilization**, and a **NOT** has been submitted to the MPCA.

- f. If sediment escapes the construction site, off-site accumulations of sediment must be removed in a manner and at a frequency sufficient to minimize off-site impacts (e.g., fugitive sediment in streets could be washed into storm sewers by the next rain and/or pose a safety hazard to users of public streets).
5. All infiltration areas must be inspected to ensure that no sediment from ongoing **construction activities** is reaching the infiltration area and these areas are protected from compaction due to construction equipment driving across the infiltration area.

F. POLLUTION PREVENTION MANAGEMENT MEASURES

The **Permittee(s)** shall implement the following pollution prevention management measures on the site:

1. **Solid Waste:** Collected sediment, asphalt and concrete millings, floating debris, paper, plastic, fabric, construction and demolition debris and other wastes must be disposed of properly and must comply with MPCA disposal requirements.
2. **Hazardous Materials:** Oil, gasoline, paint and any hazardous substances must be properly stored, including secondary containment, to prevent spills, leaks or other discharge. Restricted access to storage areas must be provided to prevent vandalism. Storage and disposal of hazardous waste must be in compliance with MPCA regulations.
3. External washing of trucks and other construction vehicles must be limited to a defined area of the site. Runoff must be contained and waste properly disposed of. No engine degreasing is allowed on site.

G. FINAL STABILIZATION

The **Permittee(s)** must ensure **final stabilization** of the site. The **Permittee(s)** must submit a **NOT** within 30 days after **final stabilization** is complete, or another **owner/operator (Permittee)** has assumed control according to Part II.B.5 over all areas of the site that have not undergone **final stabilization**. **Final stabilization** can be achieved in one of the following ways:

1. All soil disturbing activities at the site have been completed and all soils must be **stabilized** by a uniform perennial vegetative cover with a density of 70 percent over the entire pervious surface area, or other equivalent means necessary to prevent soil failure under erosive conditions and;
 - a. All drainage ditches, constructed to drain water from the site after construction is complete, must be **stabilized** to preclude erosion;
 - b. All temporary synthetic, and structural **erosion prevention** and **sediment control BMPs** (such as silt fence) must be removed as part of the site **final stabilization**; and
 - c. The **Permittee(s)** must clean out all sediment from conveyances and from temporary sedimentation basins that are to be used as permanent water quality management basins.

Sediment must be **stabilized** to prevent it from being washed back into the basin, conveyances or drainageways discharging off-site or to **surface waters**. The cleanout of permanent basins must be sufficient to return the basin to design capacity.

2. For residential construction only, **final stabilization** has been achieved when **temporary erosion protection** and down gradient perimeter control for individual lots has been completed and the residence has been transferred to the homeowner. Additionally, the **Permittee** must distribute the MPCA "**homeowner factsheet**" to the homeowner to inform the homeowner of the need for, and benefits of, **final stabilization**.

PART V. GENERAL PROVISIONS

A. APPLICABILITY CRITERIA

1. If the **Commissioner** determines that **storm water** discharges associated with a **construction activity** are contributing to a violation of a water quality standard or would be more appropriately regulated by an individual permit, the **Commissioner** may require the **owner** to be covered by an individual **storm water** discharge permit. The **Commissioner** may require the **owner** to develop and implement specific **BMPs** and monitor the discharge from the site. If applicable, upon issuance of an individual permit, this general permit would no longer apply.
2. If the terms and conditions of this general permit cannot be met, an **owner** may request an individual permit, in accordance with Minn. R. 7001.

B. RESPONSE

The **SWPPP**, including all certificates, reports, records, or other information required by this permit, must be made available to federal, state, and local officials within 72 hours upon request for the duration of the permit and for three years following the **NOT**. This does not include any records after submittal of the **NOT**.

C. PROHIBITIONS

This permit prohibits discharges of any material other than **storm water**, and discharges from **dewatering** or basin draining activities in accordance with Part IV.D.1 and 2. For example, prohibited discharges include but are not limited to vehicle and equipment washing, maintenance spills, wash water, and discharges of oil and other hazardous substances.

D. TRANSFER OF OWNERSHIP OR CONTROL

This permit may not be assigned or transferred by the permit holder except when transfer occurs in accordance with the applicable requirements of Part II.B.5.

E. CIVIL AND CRIMINAL LIABILITY

Nothing in this permit must be construed to relieve the **Permittee(s)** from civil or criminal penalties for noncompliance with the terms and conditions provided herein. Nothing in this permit must be construed to preclude the initiation of any legal action or relieve the **Permittee(s)** from any responsibilities, liabilities, or penalties to which the **Permittee(s)** is or may be subject to under Section 311 of the Act and Minn. Stat. chs. 115 and 116, as amended. The **Permittee(s)** are not liable

for permit requirements for activities occurring on those portions of a site where another party has submitted a subdivision short form registration as described in Part II. B.5 or a **NOT** has been issued by the MPCA except for responsibilities listed under Part III.C.5 if applicable.

F. SEVERABILITY

The provisions of this permit are severable. If any provision of this permit, or the application of any provision of this permit to any circumstances, is held invalid, the application of such provision to other circumstances, and the remainder of this permit must not be affected thereby.

G. NPDES/SDS RULE STANDARD CONDITIONS

The **Permittee(s)** must comply with the provisions of Minn. R. 7001.0150, subp. 3 and 7001.1090, subp. 1.A,B,C,H,I. This permit does not require the submittal of a data monitoring report, except where monitoring is required in Part III.C.5.

H. INSPECTION AND ENTRY

The **Permittee(s)** must comply with the provisions of 40 CFR 122.41(i), Minn. Stat. Ch. 115.04 and Minn. Stat. Ch. 115B.17. The **Permittee(s)** shall allow representatives of the MPCA or any member, employee or agent thereof, when authorized by it, upon presentation of credentials, to enter upon any property, public or private, for the purpose of obtaining information or examination of records or conducting surveys or investigations.

APPENDIX A

A. GENERAL REQUIREMENTS

All requirements in this Appendix are in addition to **BMPs** already specified in the permit. Where provisions of Appendix A conflict with requirements elsewhere in the permit, the provisions in Appendix A take precedence. All **BMPs** used to comply with this Appendix must be documented in the **SWPPP** for the project. If the terms and conditions of this Appendix cannot be met, an individual permit will be required in accordance with Minn. R. ch. 7001.

B. REQUIREMENTS FOR DISCHARGES TO SPECIAL WATERS

Additional **BMPs** together with enhanced runoff controls, are required for discharges to the following special waters (part B.1 through B.8 of Appendix A). The **BMPs** identified for each special water are required for those areas of the project draining to a discharge point on the project that is within 2000 feet of a special water and flows to that special water.

1. **Wilderness areas:** Boundary Waters Canoe Area Wilderness; Voyageurs National Park; Kettle River from the site of the former dam at Sandstone to its confluence with the Saint Croix River; Rum River from Ogechie Lake spillway to the northernmost confluence with Lake Onamia. Discharges to these waters must incorporate the **BMPs** outlined in C.1, C.2, C.3 and C.4 of this appendix.
2. **Mississippi River:** Those portions from Lake Itasca to the southerly boundary of Morrison County that are included in the Mississippi Headwaters Board comprehensive plan dated

February 12, 1981. Discharges to these waters must incorporate the **BMPs** outlined in C.1, C.2 and C.3 of this appendix.

3. **Scenic or recreational river segments:** Saint Croix river, entire length; Cannon River from northern city limits of Faribault to its confluence with the Mississippi River; North Fork of the Crow River from Lake Koronis outlet to the Meeker-Wright county line; Kettle River from north Pine County line to the site of the former dam at Sandstone; Minnesota River from Lac qui Parle dam to Redwood County state aid highway 11; Mississippi River from county state aid highway 7 bridge in Saint Cloud to northwestern city limits of Anoka; and Rum River from state aid Highway 27 bridge in Onamia to Madison and Rice streets in Anoka. Discharges to these waters must incorporate the **BMPs** outlined in C.1, C.2 and C.3 of this appendix.
4. **Lake Superior:** (prohibited and restricted) Discharges to Lake Superior must incorporate the **BMPs** outlined in C.1, C.2 and C.3 of this appendix.
5. **Lake Trout Lakes:** Identified in Minn. R. 7050.0470, including those inside the boundaries of the Boundary Waters Canoe Area Wilderness and Voyageurs National Park. Discharges to these waters must incorporate the **BMPs** outlined in C.1, C.2, C.3 and C.4 of this appendix.
6. **Trout Lakes:** identified in Minn. R. 6264.0050, subp. 2. Discharges to these waters must incorporate the **BMPs** outlined in C.1, C.2, C.3, and C.4 of this appendix.
7. **Scientific and natural areas:** Boot Lake, Anoka County; Kettle River in sections 15, 22, 23, T 41 N, R 20, Pine County; Pennington Bog, Beltrami County; Purvis Lake-Ober Foundation, Saint Louis County; Waters within the borders of Itasca Wilderness Sanctuary, Clearwater County; Iron Springs Bog, Clearwater County; Wolsfeld Woods, Hennepin County; Green Water Lake, Becker County; Blackdog Preserve, Dakota County; Prairie Bush Clover, Jackson County; Black Lake Bog, Pine County; Pembina Trail Preserve, Polk County; and Falls Creek, Washington County. Discharges to these waters must incorporate the **BMPs** outlined in C.1, C.2, C.3 and C.4 of this appendix.
8. **Trout Streams:** listed in Minn. R. 6264.0050, subp. 4. Discharges to these waters must incorporate the **BMPs** outlined in Appendix A C.1, C.2, C.3, and C.5 of this appendix.

C. ADDITIONAL BMPS FOR SPECIAL WATERS

For the BMPs described in C.2, C.4 and C.5 of this Appendix:

Where the proximity to bedrock precludes the installation of any of the permanent **storm water** management practices outlined in Appendix A, other treatment such as grassed swales, smaller ponds, or grit chambers is required prior to discharge to **surface waters**.

For work on road projects where the lack of right of way precludes the installation of any of the permanent **storm water** management practices outlined in Appendix A, other treatment such as grassed swales, smaller ponds, or grit chambers is required prior to discharge to **surface waters**.

1. During construction.
 - a. All exposed soil areas with a slope of 3:1 or steeper, that have a continuous positive slope to a special water must have **temporary erosion protection** or **permanent cover** within 3 days

- after the area is no longer actively being worked. All other slopes that have a continuous positive slope to a special water must have **temporary erosion protection** or **permanent cover** within 7 days after the area is no longer actively being worked.
- b. Temporary sediment basin requirements described in Part III.B.1-5 must be used for common drainage locations that serve an area with five (5) or more acres disturbed at one time.
2. Post construction. The **water quality volume** that must be treated by the project's permanent **storm water** management system described in Part III.C. shall be one (1) inch of runoff from the new **impervious surfaces** created by the project.
 3. Buffer zone. An undisturbed buffer zone of not less than 100 linear feet from the special water (not including tributaries) shall be maintained at all times. Exceptions from this requirement for areas, such as water crossings or limited water access, are allowed if the **Permittee** fully documents in the **SWPPP** the circumstances and reasons that the buffer encroachment is necessary. All potential water quality, scenic and other environmental impacts of these exceptions must be minimized and documented in the **SWPPP** for the project.
 4. Enhanced runoff controls. The permanent **storm water** management system must be designed such that the pre and post project runoff rate and volume from the 1, and 2-year 24-hour precipitation events remains the same.
 5. Temperature Controls. The permanent **storm water** management system must be designed such that the discharge from the project will minimize any increase in the temperature of trout stream receiving waters resulting from the 1, and 2-year 24-hour precipitation events. This includes all tributaries of designated trout streams within the section that the trout stream is located. Projects that discharge to trout streams must minimize the impact using one or more of the following measures, in order of preference:
 - a. Minimize new **impervious surfaces**.
 - b. Minimize the discharge from connected **impervious surfaces** by discharging to vegetated areas, or grass swales, and through the use of other non-structural controls.
 - c. Infiltration or evapotranspiration of runoff in excess of pre-project conditions (up to the 2-year 24-hour precipitation event).
 - d. If ponding is used, the design must include an appropriate combination of measures such as shading, filtered bottom withdrawal, vegetated swale discharges or constructed **wetland** treatment cells that will limit temperature increases. The pond should be designed to draw down in 24 hours or less.
 - e. Other methods that will minimize any increase in the temperature of the trout stream.

D. REQUIREMENTS FOR DISCHARGING TO WETLANDS

If the project has any **storm water** discharges with the potential for significant adverse impacts to a **wetland** (e.g., conversion of a natural **wetland** to a **storm water** pond), the **Permittee(s)** must demonstrate that the **wetland** mitigative sequence has been followed in accordance with D.1 or D.2 of this appendix.

1. If the potential adverse impacts to a **wetland** on a specific project site have been addressed by permits or other approvals from an official statewide program (U.S. Army Corps of Engineers 404 program, Minnesota Department of Natural Resources, or the State of Minnesota Wetland

Conservation Act) that are issued specifically for the project and project site, the **Permittee** may use the permit or other determination issued by these agencies to show that the potential adverse impacts have been addressed. For the purposes of this permit, de minimus actions are determinations by the permitting agency that address the project impacts, whereas a non-jurisdictional determination does not address project impacts.

2. If there are impacts from the project that are not addressed in one of the permits or other determinations discussed in Appendix A, Part D.1 (e.g., permanent inundation or flooding of the **wetland**, significant degradation of water quality, excavation, filling, draining), the **Permittee** must minimize all adverse impacts to **wetlands** by utilizing appropriate measures. Measures used must be based on the nature of the **wetland**, its vegetative community types and the established hydrology. These measures include in order of preference:
 - a. Avoid all significant adverse impacts to **wetlands** from the project and post project discharge.
 - b. Minimize any unavoidable impacts from the project and post project discharge.
 - c. Provide compensatory mitigation when the **Permittee** determines that there is no reasonable and practicable alternative to having a significant adverse impact on a **wetland**. For compensatory mitigation, wetland restoration or creation shall be of the same type, size and whenever reasonable and practicable in the same watershed as the impacted wetland.

E. DISCHARGES REQUIRING ENVIRONMENTAL REVIEW

This permit does not replace or satisfy any environmental review requirements, including those under the Minnesota Environmental Policy Act (MEPA) or the National Environmental Policy Act (NEPA). The **owner** must complete any environmental review required by law, including any required Environmental Assessment Work Sheets or Environmental Impact Statements, Federal environmental review, or other required review.

F. DISCHARGES AFFECTING ENDANGERED OR THREATENED SPECIES

This permit does not replace or satisfy any review requirements for Endangered or Threatened species, from new or **expanded discharges** that adversely impact or contribute to adverse impacts on a listed endangered or threatened species or adversely modify a designated critical habitat. The **owner** must conduct any required review and coordinate with appropriate agencies for any project with the potential of affecting threatened or endangered species, or their critical habitat.

G. DISCHARGES AFFECTING HISTORIC PLACES OR ARCHEOLOGICAL SITES

This permit does not replace or satisfy any review requirements for Historic Places or Archeological Sites, from new or **expanded discharges** which adversely affect properties listed or eligible for listing in the National Register of Historic Places or affecting known or discovered Archeological Sites. The **owner** must be in compliance with National Historic Preservation Act and conduct all required review and coordination related to historic preservation, including significant anthropological sites and any burial sites, with the Minnesota Historic Preservation Officer.

APPENDIX B. DEFINITIONS

1. "**Best Management Practices (BMPs)**" means erosion and **sediment control** and water quality management practices that are the most effective and practicable means of controlling, preventing, and minimizing degradation of **surface water**, including avoidance of impacts, construction-phasing, minimizing the length of time soil areas are exposed, prohibitions, and other management practices published by state or designated area-wide planning agencies.

Individual **BMPs** found in this permit are described in the current version of **Protecting Water Quality in Urban Areas**, Minnesota Pollution Control Agency 2000. **BMPs** must be adapted to the site and can be adopted from other sources. However, they must be similar in purpose and at least as effective and stringent as MPCA's **BMPs**. (Other sources include manufacturers specifications, **Storm Water Management for Construction Activities: Developing Pollution Prevention Plans and Best Management Practices**, U.S. Environmental Protection Agency 1992, and **Erosion Control Design Manual**, Minnesota Department of Transportation, et al, 1993).

2. "**Commissioner**" means the **Commissioner** of the Minnesota Pollution Control Agency or the **Commissioner's** designee.
3. "**Common Plan of Development or Sale**" means a contiguous area where multiple separate and distinct land disturbing activities may be taking place at different times, on different schedules, but under one proposed plan. One plan is broadly defined to include design, permit application, advertisement or physical demarcation indicating that land-disturbing activities may occur.
4. "**Construction Activity**" For this permit, **construction activity** includes **construction activity** as defined in 40 C.F.R. part 122.26(b)(14)(x) and **small construction activity** as defined in 40 C.F.R. part 122.26(b)(15). This includes a disturbance to the land that results in a change in the topography, existing soil cover (both vegetative and non-vegetative), or the existing soil topography that may result in accelerated **storm water** runoff, leading to soil erosion and movement of sediment into **surface waters** or drainage systems. Examples of construction activity may include clearing, grading, filling and excavating. **Construction activity** includes the disturbance of less than one acre of total land area that is a part of a larger **common plan of development or sale** if the larger common plan will ultimately disturb one (1) acre or more.
5. "**Dewatering**" means the removal of water for **construction activity**. It can be a discharge of appropriated surface or groundwater to dry and/or solidify a construction site. It may require Minnesota Department of Natural Resources permits to be appropriated and if contaminated may require other MPCA permits to be discharged.
6. "**Energy Dissipation**" means methods employed at pipe outlets to prevent erosion. Examples include, but are not limited to: concrete aprons, riprap, splash pads, and gabions that are designed to prevent erosion.
7. "**Erosion Prevention**" means measures employed to prevent erosion including but not limited to: soil stabilization practices, limited grading, mulch, temporary or **permanent cover**, and construction phasing.
8. "**Final Stabilization**" means that either:
 - a. All soil disturbing activities at the site have been completed and a uniform (e.g., evenly distributed, without large bare areas) perennial vegetative cover with a density of 70% of the

native background vegetative cover for the area has been established on all unpaved areas and areas not covered by permanent structures, or equivalent permanent stabilization measures (such as the use of riprap, gabions, or geotextiles) have been employed;

- b. For individual lots in residential construction by either: (a) The homebuilder completing **final stabilization** as specified above, or (b) the homebuilder establishing temporary stabilization including perimeter controls for an individual lot prior to occupation of the home by the homeowner and informing the homeowner of the need for, and benefits of, **final stabilization**. (Homeowners typically have an incentive to put in the landscaping functionally equivalent to **final stabilization** as quick as possible to keep mud out of their homes and off sidewalks and driveways.); or
 - c. For construction projects on land used for agricultural purposes (e.g., pipelines across crop or range land) **final stabilization** may be accomplished by returning the disturbed land to its preconstruction agricultural use. Areas disturbed that were not previously used for agricultural activities, such as buffer strips immediately adjacent to **surface waters** and drainage systems, and areas which are not being returned to their preconstruction agricultural use must meet the **final stabilization** criteria in (a) or (b) above.
9. "**General Contractor**" means the party who signs the construction contract with the **owner** to construct the project described in the final plans and specifications. Where the construction project involves more than one contractor, the **general contractor** will be the party responsible for managing the project on behalf of the **owner**. In some cases, the **owner** may be the **general contractor**. In these cases, the **owner** may contract an individual as the **operator** who would become the Co-Permittee.
 10. "**Homeowner Factsheet**" means a fact sheet developed by the MPCA to be given to homeowners at the time of sale by a builder to inform the homeowner of the need for, and benefits of, **final stabilization**.
 11. "**Impervious Surface**" means a constructed hard surface that either prevents or retards the entry of water into the soil and causes water to run off the surface in greater quantities and at an increased rate of flow than prior to development. Examples include rooftops, sidewalks, patios, driveways, parking lots, storage areas, and concrete, asphalt, or gravel roads.
 12. "**National Pollutant Discharge Elimination System (NPDES)**" means the program for issuing, modifying, revoking, reissuing, terminating, monitoring, and enforcing permits under the Clean Water Act (Sections 301, 318, 402, and 405) and United States Code of Federal Regulations Title 33, Sections 1317, 1328, 1342, and 1345..
 13. "**Normal Wetted Perimeter**" means the area of a conveyance, such as a ditch, channel, or pipe that is in contact with water during flow events that are expected to occur once every year.
 14. "**Notice of Termination**" means notice to terminate coverage under this permit after construction is complete, the site has undergone **final stabilization**, and maintenance agreements for all permanent facilities have been established, in accordance with all applicable conditions of this permit. **Notice of Termination** forms are available from the MPCA.
 15. "**Operator**" means the person (usually the **general contractor**), designated by the **owner**, who has day to day operational control and/or the ability to modify project plans and specifications related to

the **SWPPP**. The person must be knowledgeable in those areas of the permit for which the **operator** is responsible, (Part II.B. and Part IV.) and must perform those responsibilities in a workmanlike manner.

16. "**Owner**" means the person or party possessing the title of the land on which the construction activities will occur; or if the **construction activity** is for a lease holder, the party or individual identified as the lease holder; or the contracting government agency responsible for the **construction activity**.
17. "**Permanent Cover**" means **final stabilization**. Examples include grass, gravel, asphalt, and concrete.
18. "**Permittee**" means a person or persons, firm, or governmental agency or other institution that signs the application submitted to the MPCA and is responsible for compliance with the terms and conditions of this permit.
19. "**Saturated Soil**" means the highest seasonal elevation in the soil that is in a reduced chemical state because of soil voids being filled with water. **Saturated soil** is evidenced by the presence of redoximorphic features or other information.
20. "**Sediment Control**" means methods employed to prevent sediment from leaving the site. **Sediment control** practices include silt fences, sediment traps, earth dikes, drainage swales, check dams, subsurface drains, pipe slope drains, storm drain inlet protection, and temporary or permanent sedimentation basins.
21. "**Small Construction Activity**" means small construction activity as defined in 40 C.F.R. part 122.26(b)(15). Small construction activities include clearing, grading and excavating that result in land disturbance of equal to or greater than one acre and less than five acres. **Small construction activity** includes the disturbance of less than one (1) acre of total land area that is part of a larger **common plan of development or sale** if the larger common plan will ultimately disturb equal to or greater than one and less than five (5) acres.
22. "**Stabilized**" means the exposed ground surface has been covered by appropriate materials such as mulch, staked sod, riprap, wood fiber blanket, or other material that prevents erosion from occurring. Grass seeding is not stabilization.
23. "**Standard Plates**" means general drawings having or showing similar characteristics or qualities that are representative of a construction practice or activity.
24. "**Storm water**" is defined under Minn. R. 7077.0105, subp. 41(b), and includes precipitation runoff, **storm water** runoff, snow melt runoff, and any other surface runoff and drainage.
25. "**Storm Water Pollution Prevention Plan**" means a plan for **storm water** discharge that includes **erosion prevention** measures and **sediment controls** that, when implemented, will decrease soil erosion on a parcel of land and decrease off-site nonpoint pollution.
26. "**Surface Water or Waters**" means all streams, lakes, ponds, marshes, **wetlands**, reservoirs, springs, rivers, drainage systems, waterways, watercourses, and irrigation systems whether natural or artificial, public or private.

27. "**Temporary Erosion Protection**" means methods employed to prevent erosion. Examples of temporary cover include; straw, wood fiber blanket, wood chips, and erosion netting.
28. "**Underground Waters**" means water contained below the surface of the earth in the saturated zone including, without limitation, all waters whether under confined, unconfined, or perched conditions, in near surface unconsolidated sediment or regolith, or in rock formations deeper underground. The term ground water shall be synonymous with underground water.
29. "**Waters of the State**" (as defined in Minn. Stat. § 115.01, subd. 22) means all streams, lakes, ponds, marshes, watercourses, waterways, wells, springs, reservoirs, aquifers, irrigation systems, drainage systems and all other bodies or accumulations of water, surface or underground, natural or artificial, public or private, which are contained within, flow through, or border upon the state or any portion thereof.
30. "**Water Quality Volume**" means ½ inch of runoff from the new **impervious surfaces** created by this project and is the volume of water to be treated in the permanent **storm water** management system, as required by this permit except as provided in Appendix A.C.2.
31. "**Wetland**" or "**Wetlands**" is defined in Minn. R. 7050.0130, subp. F and includes those areas that are inundated or saturated by surface water or groundwater at a frequency and duration sufficient to support, and that under normal circumstances do support, a prevalence of vegetation typically adapted for life in **saturated soil** conditions. **Wetlands** generally include swamps, marshes, bogs, and similar areas. Constructed **wetlands** designed for wastewater treatment are not **waters of the state**. **Wetlands** must have the following attributes:
- a. A predominance of hydric soils;
 - b. Inundated or saturated by **surface water** or groundwater at a frequency and duration sufficient to support a prevalence of hydrophytic vegetation typically adapted for life in a **saturated soil** condition; and
 - c. Under normal circumstances support a prevalence of such vegetation.

Appendix B
Erosion Control Details

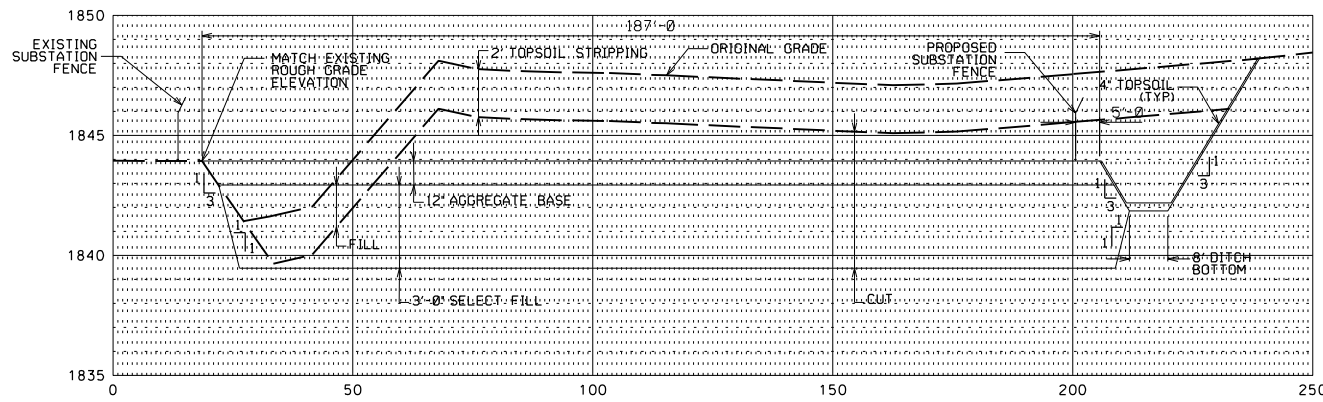

SECTION F-F

HORIZONTAL SCALE 1"= 20'
VERTICAL SCALE 1"= 4'

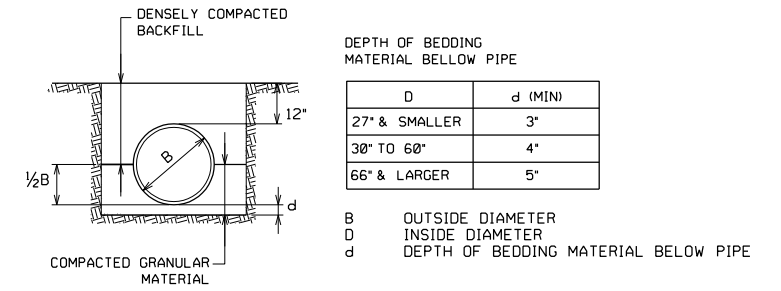

TYPICAL CULVERT BEDDING SECTION

SCALE: NONE

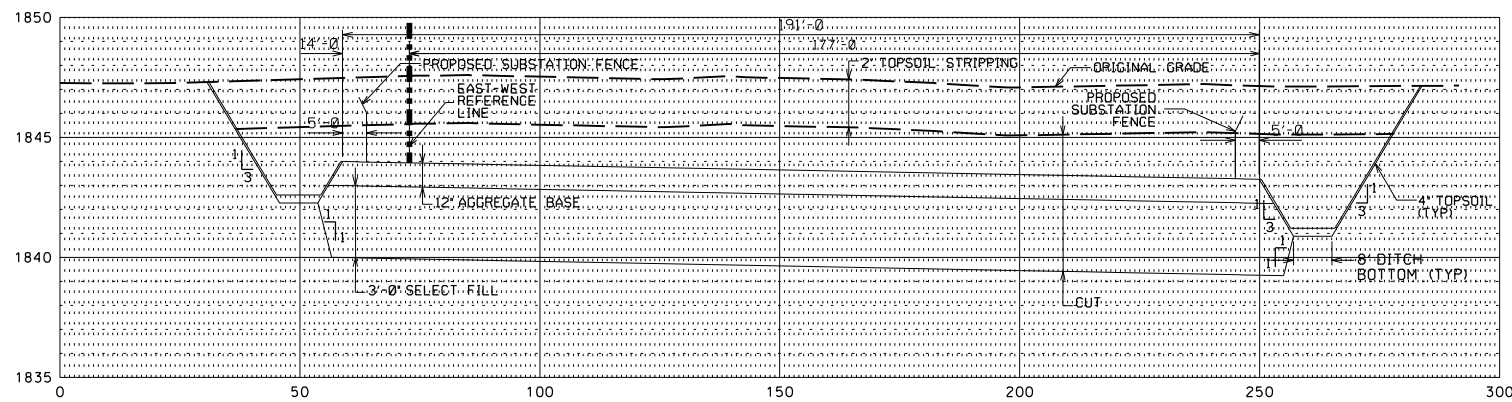

SECTION G-G

HORIZONTAL SCALE 1"= 20'
VERTICAL SCALE 1"= 4'

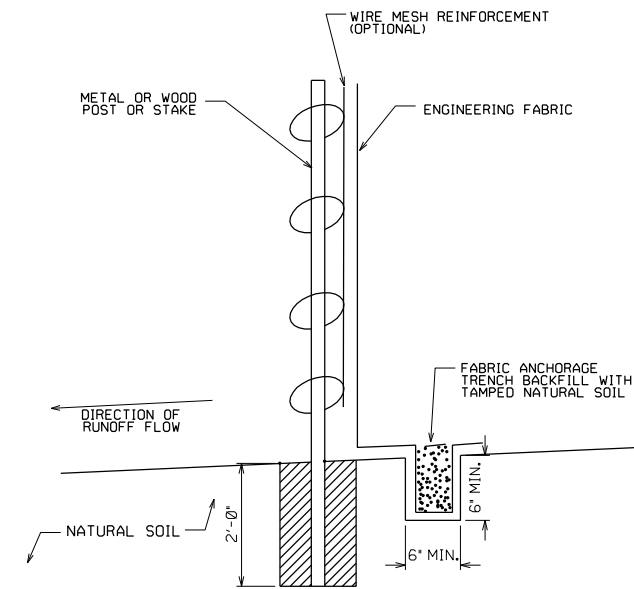

DETAIL B

SILT FENCE SECTION
SCALE: NONE

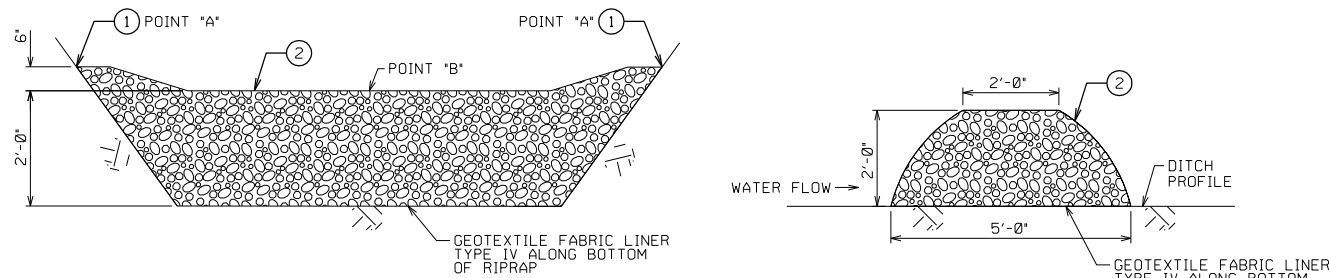

CROSS SECTION
ROCK CHECK DITCH CHECK

PROFILE VIEW
ROCK CHECK DITCH CHECK

NOTES:

- 1 POINT "A" MUST BE A MINIMUM OF 6" HIGHER THAN POINT "B" TO ENSURE THAT WATER FLOWS OVER THE DIKE AND NOT AROUND THE ENDS.
- 2 CLASS I-IV RIPRAP WITH GEOTEXTILE FABRIC LINER, TYPE IV.

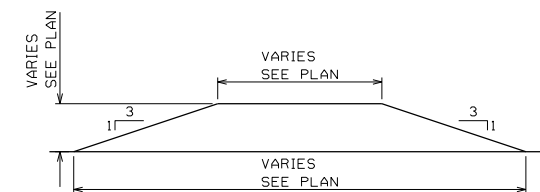

SECTION H-H

SCALE: NONE

REFERENCE DRAWING:

TOPOGRAPHY LAYOUT ----- NH-158205
GRADING LAYOUT ----- NH-158184-1

THIS MAP/DOCUMENT IS A TOOL TO ASSIST EMPLOYEES IN THE PERFORMANCE OF THEIR JOBS. YOUR PERSONAL SAFETY IS PROVIDED FOR BY USING SAFETY PRACTICES, PROCEDURES AND EQUIPMENT AS DESCRIBED IN THE SAFETY TRAINING PROGRAMS, MANUALS AND SPARS.		SIGNIFICANT NUMBER 1 6082 2 3 4 5A 6230 5B 6 CL
ENGINEERING DEPARTMENT MINNEAPOLIS, MN	CHANARAMBIE SUBSTATION (CHA) CONTOUR & GRADING LAYOUT SH.3 SECTIONS	
Xcel Energy		SCALE AS SHOWN NH-158184-3
		REV D

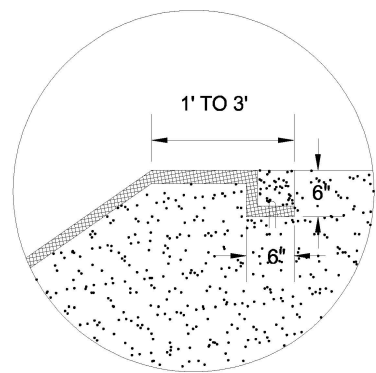
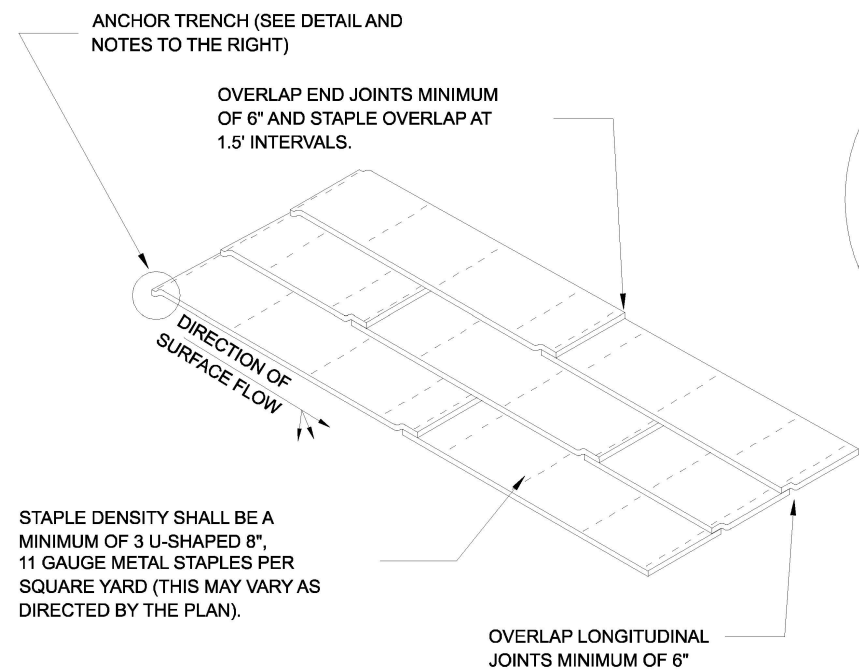

- ANCHOR TRENCH**
1. DIG 6" X 6" TRENCH
 2. LAY BLANKET IN TRENCH
 3. STAPLE AT 1.5' INTERVALS
 4. BACKFILL WITH NATURAL SOIL AND COMPACT
 5. BLANKET LENGTH SHALL NOT EXCEED 100' WITHOUT AN ANCHOR TRENCH

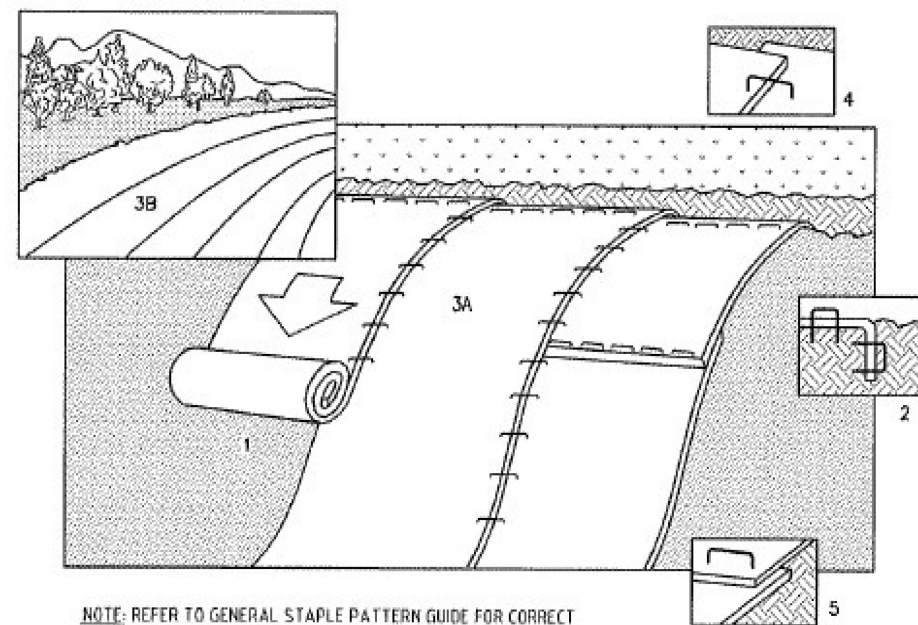

BLANKET INSTALLATION

SLOPES FLATTER THAN 1:2
(1.2 STAPLES PER SQ. YD.)

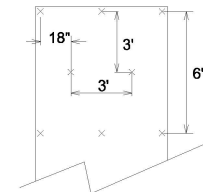

SLOPES 1:2 TO 1:1
(1.7 STAPLES PER SQ. YD.)

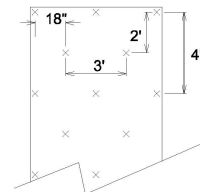

CHANNEL AND DITCH APPLICATIONS
(3.5 STAPLES PER SQ. YD.)

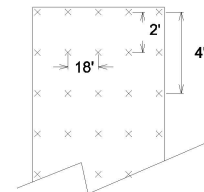

STANDARD 6' BLANKET

SLOPES FLATTER THAN 1:2
(1.2 STAPLES PER SQ. YD.)

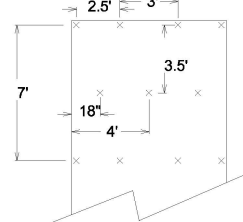

SLOPES 1:2 TO 1:1
(1.7 STAPLES PER SQ. YD.)

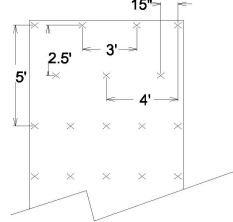

CHANNEL AND DITCH APPLICATIONS
(3.5 STAPLES PER SQ. YD.)

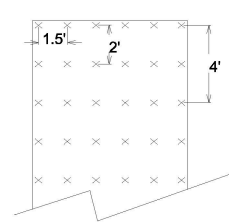

BLANKET STAPLING PATTERN

STANDARD 8' BLANKET

NOTE: HORIZONTAL STAPLE SPACING SHOULD BE ALTERED IF NECESSARY TO ALLOW STAPLES TO SECURE THE CRITICAL POINTS ALONG THE CHANNEL SURFACE. REFER TO GENERAL STAPLE PATTERN GUIDE FOR CORRECT STAPLE RECOMMENDATIONS FOR CHANNELS.

CRITICAL POINTS

- A. OVERLAPS AND SEAMS
- B. PROJECTED WATER LINE
- C. CHANNEL BOTTOM/SIDE SLOPE VERTICES

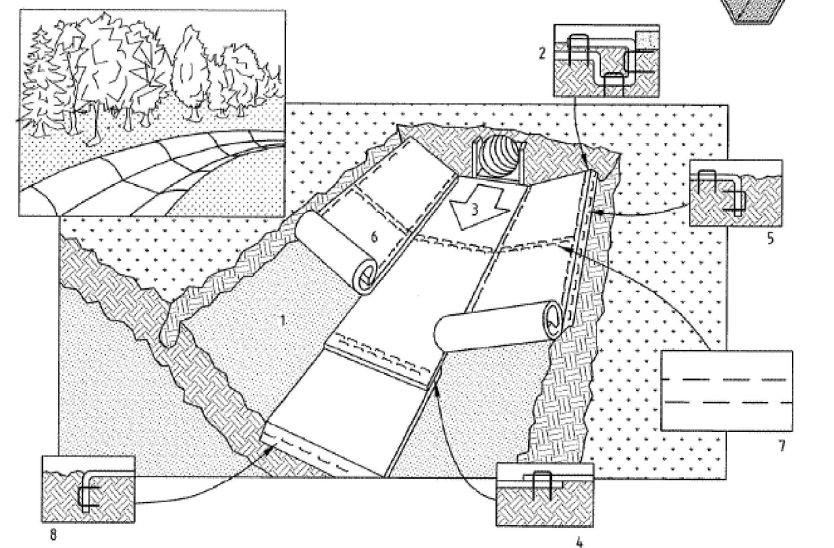

1. PREPARE SOIL BEFORE INSTALLING BLANKETS, INCLUDING APPLICATION OF LIME, FERTILIZER, AND SEED.

2. BEGIN AT THE TOP OF THE SLOPE BY ANCHORING THE BLANKET IN 6-INCH DEEP BY 6-INCH WIDE TRENCH. BACKFILL AND COMPACT THE TRENCH AFTER STAPLING.

3. ROLL THE BLANKETS (A) DOWN OR (B) HORIZONTALLY ACROSS THE SLOPE.

4. THE EDGES OF PARALLEL BLANKETS MUST BE STAPLED WITH APPROXIMATELY 2 INCH OVERLAP.

5. WHEN BLANKETS MUST BE SPLICED DOWN THE SLOPE, PLACE BLANKETS END OVER END (SHINGLE STYLE) WITH APPROXIMATELY 4 INCH OVERLAP. STAPLE THROUGH OVERLAPPED AREA, APPROXIMATELY 12 INCHES APART.

6. IN HIGH FLOW CHANNEL APPLICATIONS, A STAPLE CHECK SLOT IS RECOMMEND AT 30 TO 40 FOOT INTERVALS. USE A ROW OF STAPLES 4 INCH APART OVER THE ENTIRE WIDTH OF THE CHANNEL. PLACE A SECOND ROW 4 INCH BELOW THE FIRST ROW IN A STAGGED PATTERN.

7. THE TERMINAL END OF THE BLANKETS MUST BE ANCHORED IN A 6 INCH DEEP BY 6 INCH DEEP TRENCH. BACKFILL AND COMPACT THE TRENCH AFTER STAPLING.

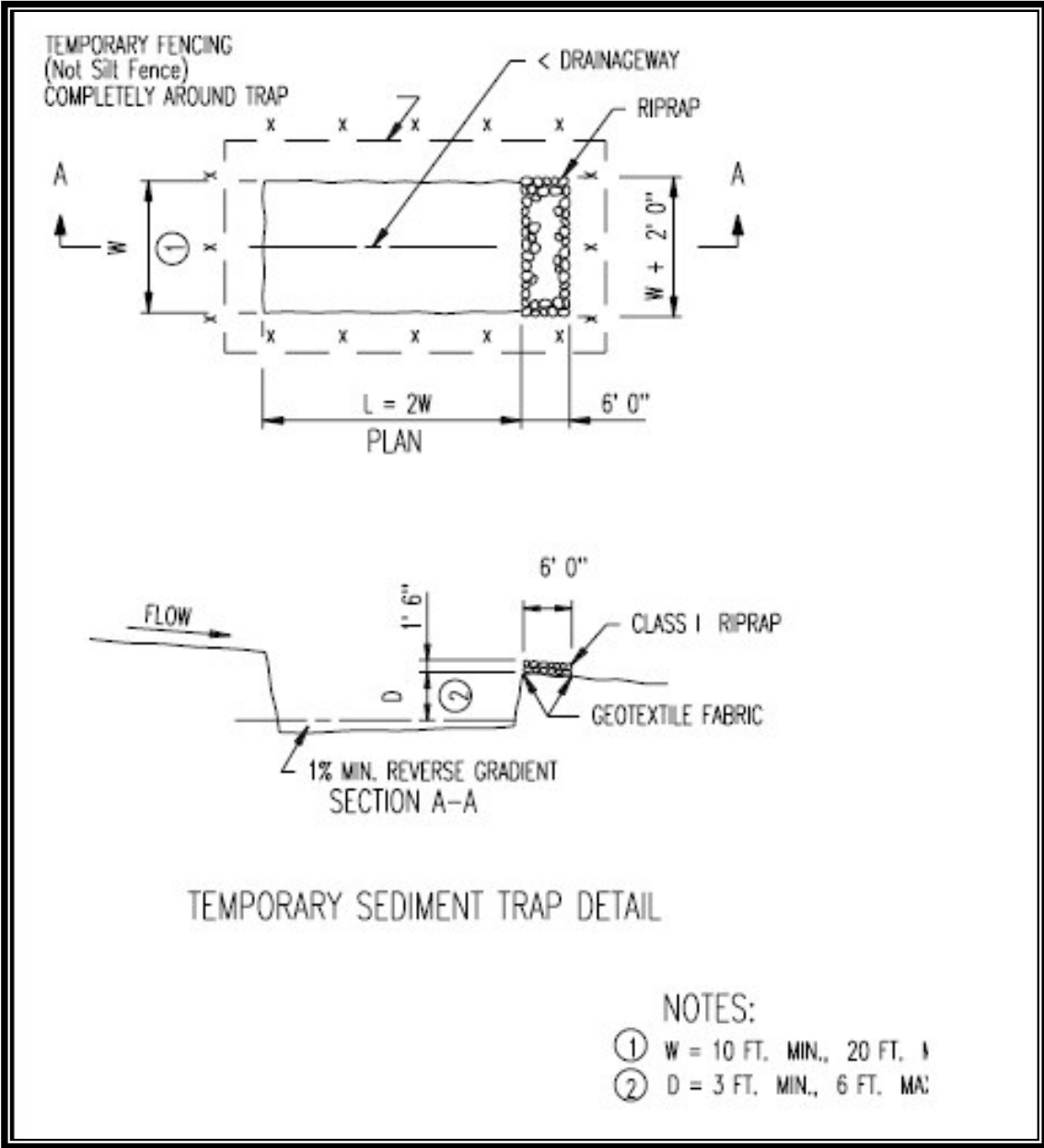

DETAIL EC - 0 4

Appendix C
Seed Mixture Composition

Mixture 150			
Common Name	Bulk Rate		Percent of Mix Component
	kg/ha	lb/ac	
Rye-grass, perennial	16.8	15	37.5
Wheat-grass, slender	5.6	5	12.5
Red clover	11.2	10	25.0
Alfalfa, vernal	11.2	10	25.0
Grand Total	44.8	40	100.0

Mixture 190			
Common Name	Bulk Rate		Percent of Mix Component
	kg/ha	lb/ac	
Red clover	6.7	6	10.0
Alsike clover	4.7	4.2	7.0
Alfalfa, creeping	10.7	9.6	16.0
Brome grass, smooth	8.1	7.2	12.0
Rye-grass, perennial	16.8	15	25.0
Wheat-grass, slender	3.4	3	5.0
Vetch, hairy	16.8	15	25.0
Grand Total	67.2	60	100.0

Mixture 250			
Common Name	Bulk Rate		Percent of Mix Component
	kg/ha	lb/ac	
Brome grass, smooth	11.0	9.8	14.0
Bluegrass, Kentucky “Certified Park”	22.7	20.3	29.0
Bluegrass, Canada	11.0	9.8	14.0
Switch grass	2.4	2.1	3.0
Wheat-grass, slender	3.1	2.8	4.0
Rye-grass, perennial	16.5	14.7	21.0
Timothy	2.4	2.1	3.0
Redtop	2.4	2.1	3.0
Alfalfa, creeping	4.7	4.2	6.0
White Clover	2.4	2.1	3.0
Grand Total	78.6	70.0	100.0

For: General roadside excluding sandy sites

Mixture 280			
Common Name	Bulk Rate		Percent of Mix Component
	kg/ha	lb/ac	
Alfalfa, creeping	16.8	15	30.0
Brome grass, smooth	11.2	10	20.0
Redtop	3.4	3	6.0
Rye-grass, perennial	16.8	15	30.0
Switch grass	2.2	2	4.0
Timothy	2.2	2	4.0
Wheat-grass, slender	3.4	3	6.0
Grand Total	56.0	50	100.0

Appendix D
Inspection Log

Appendix E
Revision Documentation

Revision	Date	Comments
00	October 2007	Original - Draft



Appendix F
Notice of Termination



**Minnesota
Pollution
Control
Agency**

This form may be filled out electronically, printed, signed and mailed to the MPCA.

National Pollutant Discharge Elimination System (NPDES)/State Disposal System (SDS)
General Stormwater Permit for Construction Activity (MN R100001)

Notice of Termination

PLEASE SUBMIT TO:

Minnesota Pollution Control Agency
Construction Stormwater Permit Program
520 Lafayette Road North, St. Paul, MN 55155-4194

NO FEE

PLEASE READ: This Notice of Termination form should be used to terminate permit coverage of the original project permit number or the subdivision registration permit number.

Refer to the NPDES/SDS General Stormwater Permit for Construction Activity (MN R100001) and the original owner's coverage notification letter as you complete this form. Brackets '[]' are references to the General Stormwater Permit, available at the MPCA or online at www.pca.state.mn.us/water/stormwater/stormwater-c.html.

Call the MPCA Customer Assistance Center at (651) 297-2274 or toll-free (in Minnesota) at (800) 646-6247 for assistance.

I want to terminate my NPDES/SDS General Stormwater Permit:

1. **My Stormwater Permit Identification Number** is MN R100001-C000-
2. **The project name** (as listed on the initial permit) is: _____
3. **If the site was subdivided**—I certify that all subdivision registration forms have been properly terminated. Yes Not applicable—no subdivision registration form(s) were needed.

I want to terminate my NPDES/SDS Subdivision Permit:

1. **My Subdivision Permit Identification Number** is SUB 00-
2. **The lot identification number** (For example: Street Address or 'Block 1, Lot 1') is: _____
3. **The ENTIRE site has been closed for termination** because EITHER:
 - Final stabilization has been achieved on all portions of the site for which I am responsible. [Part II.C.2.a and Part IV.G], or
 - For residential construction only—I have provided temporary erosion control and down gradient perimeter control, transferred ownership, and distributed the MPCA *Sediment and Erosion Control for New Homeowners* fact sheet to the homeowners. [Part II.C.2.c.]

 *This form will not be accepted if the owner and contractor contact information sections, on the next page, are BOTH not completed and signed. If the owner is also the contractor, the owner must also fill out the contractor information section and sign again.*



This form will not be accepted if the owner and contractor contact information sections, below, are BOTH not completed and signed. If the owner is also the contractor, the owner must also fill out the contractor information section and sign again.

Note: The owner and contractor information provided below should be the same as it appeared on the original application or subdivision registration form.

Owner Information and Certification

MUST BE SIGNED

Business or Firm Name _____ () - ext. Telephone (include area code)

Last Name First Name Title E-mail

Mailing Address City State Zip Code

I understand that, as a permittee, I am legally accountable under the Clean Water Act to ensure compliance with the terms and conditions of the NPDES/SDS General Stormwater Permit for Construction Activity (MN R100001).

I understand that by submitting this Notice of Termination I am no longer authorized to discharge stormwater associated with the construction activity identified on this form under the terms and condition of the NPDES/SDS General Stormwater Permit for Construction Activity (MN R100001), and that discharging stormwater associated with a construction activity to waters of the state is unlawful under the Clean Water Act unless the discharge is authorized by an NPDES/SDS permit.

I understand the submittal of this Notice of Termination does not release my company or agency from liability for any violations of the NPDES/SDS General Stormwater Permit for Construction Activity (MN R100001) or the Clean Water Act.

I certify under penalty of law that the answers to the questions above, are true and correct, and this information is based on my own assessment or on my inquiry of the person or persons responsible for gathering the information.

X

Authorized Signature _____ Date

This form must be signed by:

- **Corporation:** a principal executive officer of at least the level of vice-president or the duly authorized representative or agent of the executive officer if the representative or agent is responsible for the overall operation of the facility that is the subject of the permit application.
- **Partnership or Sole Proprietorship:** a general partner or the proprietor.
- **Municipality, State, Federal or Other Public Agency:** principal executive officer or ranking elected official.

Contractor Information and Certification

MUST BE SIGNED

Business or Firm Name _____ () - ext. Telephone (include area code)

Last Name First Name Title E-mail

Mailing Address City State Zip Code

I understand that, as a permittee, I am legally accountable under the Clean Water Act to ensure compliance with the terms and conditions of the NPDES/SDS General Stormwater Permit for Construction Activity (MNR100001).

I understand that by submitting this Notice of Termination I am no longer authorized to discharge stormwater associated with the construction activity identified on this form under the terms and condition of the NPDES/SDS General Stormwater Permit for Construction Activity (MN R100001), and that discharging stormwater associated with a construction activity to waters of the state is unlawful under the Clean Water Act unless the discharge is authorized by an NPDES/SDS permit.

I understand the submittal of this Notice of Termination does not release my company or agency from liability for any violations of the NPDES/SDS General Stormwater Permit for Construction Activity (MN R100001) or the Clean Water Act.

I certify under penalty of law that the answers to the questions above, are true and correct, and this information is based on my own assessment or on my inquiry of the person or persons responsible for gathering the information.

X

Authorized Signature _____ Date

This form must be signed by:

- **Corporation:** a principal executive officer of at least the level of vice-president or the duly authorized representative or agent of the executive officer if the representative or agent is responsible for the overall operation of the facility that is the subject of the permit application.
- **Partnership or Sole Proprietorship:** a general partner or the proprietor.
- **Municipality, State, Federal or Other Public Agency:** principal executive officer or ranking elected official.